

KDC-Z727 Z727

SERVICE MANUAL

KDC-Z727

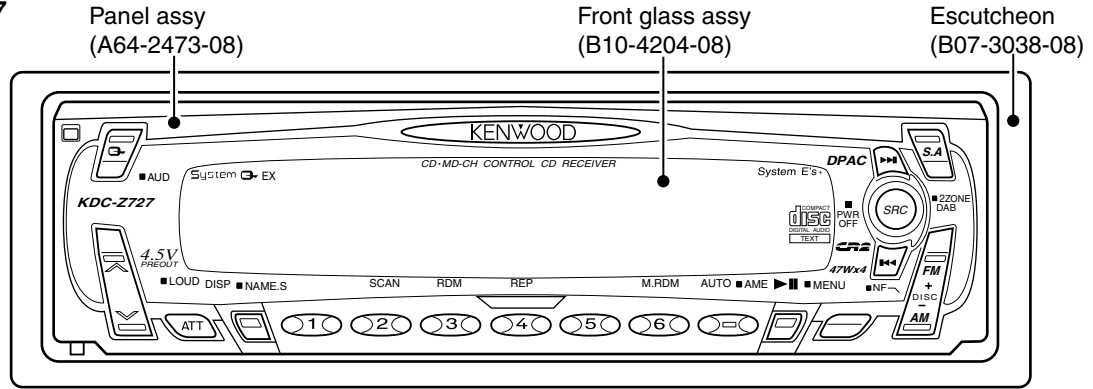

Z727

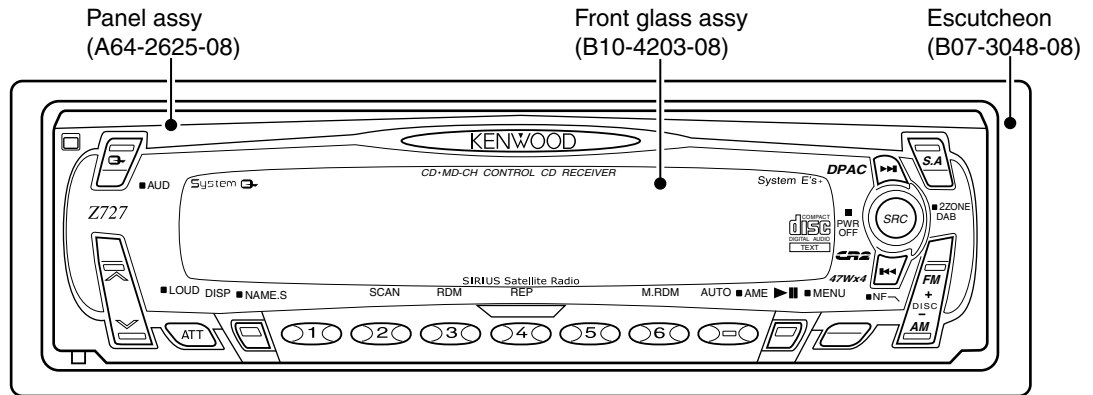

Plastic cabinet assy (A02-2711-08)

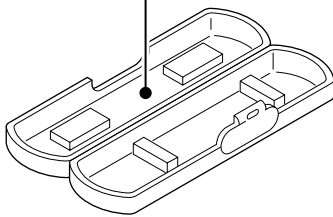

Remote controller assy (A70-0894-05)

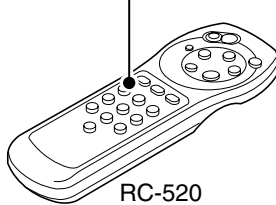

SIZE AAA BATTERY (Not supplied)

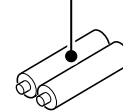

Mounting hardware assy (J21-9585-18)

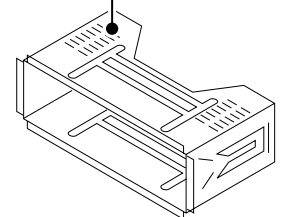

DC cord assy (E30-6021-08)

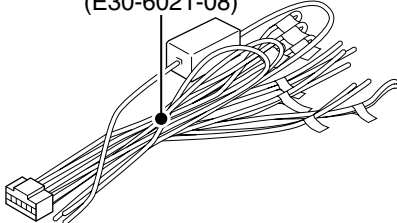

Lever (D10-4364-08)x2

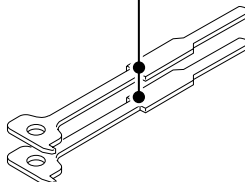

Stay (J54-0606-04)

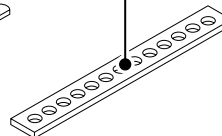

Screw set (N99-1700-05)

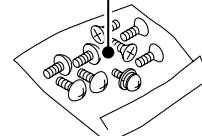

Screw set (N99-1716-08)

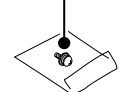

KDC-Z727,Z727

CONTENTS

BLOCK DIAGRAM	3
COMPONENTS DESCRIPTION.....	5
MICROCOMPUTER'S TERMINAL DESCRIPTION.....	6
TEST MODE	11
PC BOARD.....	12
SCHEMATIC DIAGRAM	19
EXPLODED VIEW	27
PARTS LIST	29
SPECIFICATIONS.....	BACK COVER

KDC-Z727

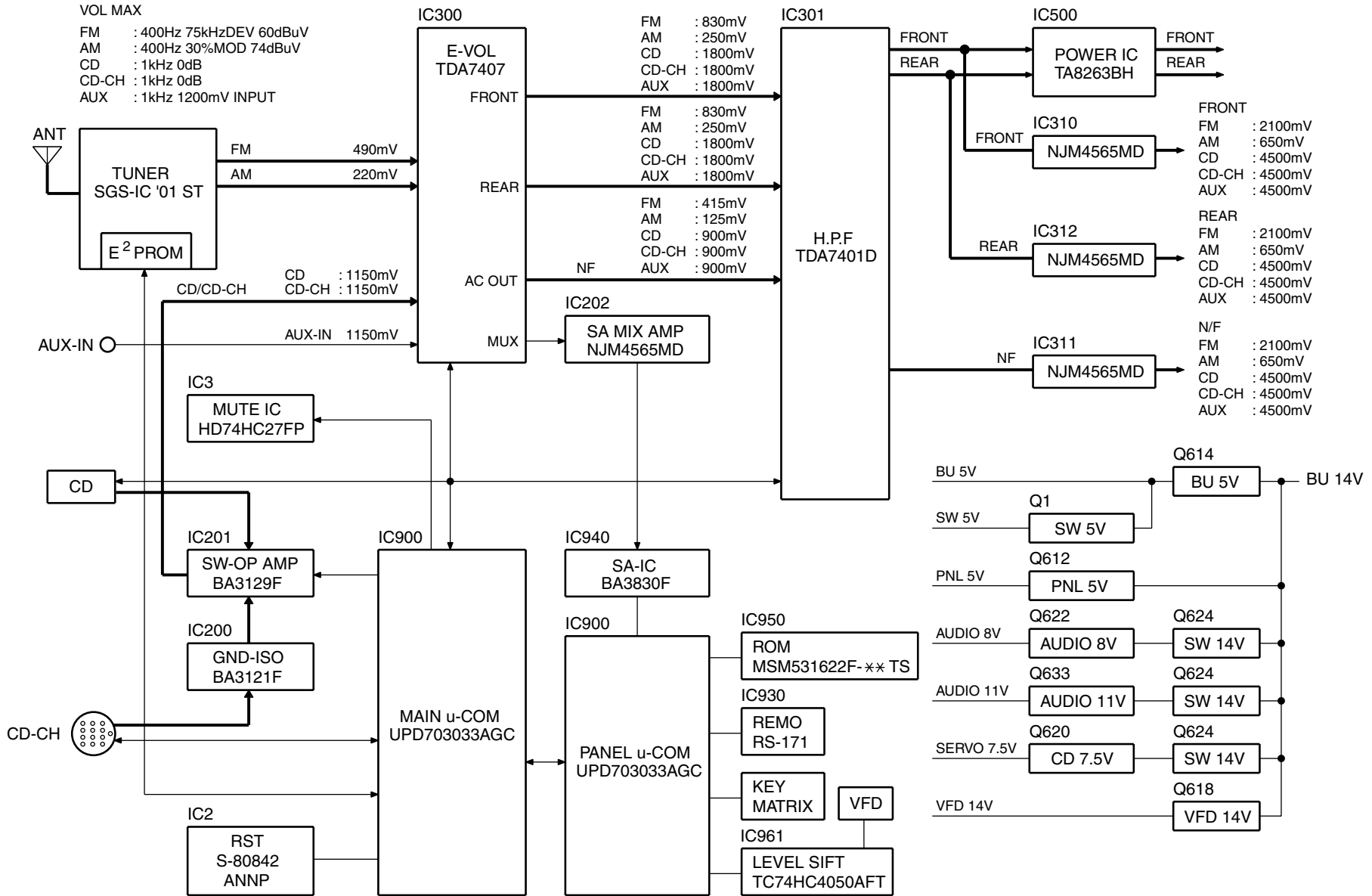

BLOCK DIAGRAM (KDC-Z727)

KDC-Z727, Z727

Z727

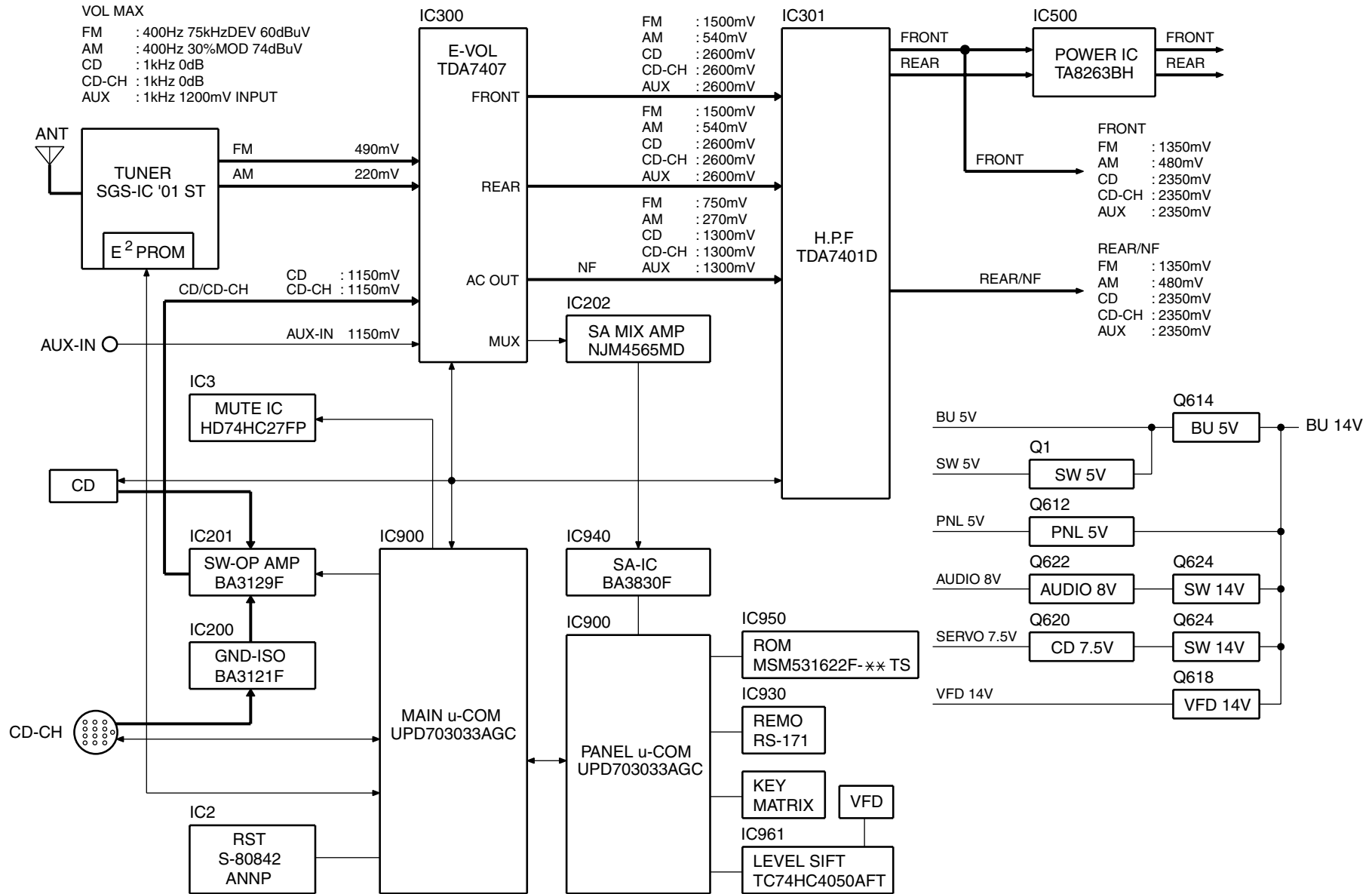

KDC-Z727, Z727
 BLOCK DIAGRAM (Z727)

KDC-Z727,Z727

COMPONENTS DESCRIPTION

Ref.No.	Element/Function	Operation/Condition
IC1	SYS u-COM	
IC2	RESET	System reset
IC3	GATE IC	Gate IC for muting
IC200	GND-ISO	GND-ISO for CD-CH
IC201	SW-OP	CD/CD-CH input switching
IC202	Buff	SA buffer and 1/2 Vdd
IC300	E-VOL/MPX	E-VOL/MPX
IC301	SYSTEM E'S	SYSTEM E'S
IC310,312	Buff	Buffer for 4.5 V PRE-OUT
IC500	POWER AMP	
IC900	PNL u-COM	
IC930	REMOCON	Remote control light sensor
IC940	SA BPF	BPF for SA
IC950	EXTENSION ROM	
IC960	3.3V POWER SUPPLY IC	3.3 V power supply
IC961	LEVEL SHIFT IC	5V-3.3 V level shifting
Q1	5V SW	
Q2	MUTE SW	Muting SW for PRE-OUT
Q3	CH RST SW	
Q4	LED SW	LED SW for DISC_ and EJ SW
Q5	PNL5V SW	
Q6	PNL5V SW	
Q9	Buff	IFC buffer
Q10	LED SW	LED SW for DSI
Q100,101	FM+B SW	
Q102,103	AM+B SW	
Q200	MD/CD-CH SW	CD/CD-CH signal switching
Q201	MUTE DRV	For SA muting
Q202	ALC	ALC
Q300	MUTE	E-VOL muting SW
Q350A,B	MUTE DRV	PRE-OUT muting
Q351A,B	MUTE DRV	PRE-OUT muting

Ref.No.	Element/Function	Operation/Condition
Q352A,B	MUTE DRV	PRE-OUT muting
Q600	BU DET	B-U ON/OFF detection
Q601	Acc DET	Acc ON/OFF detection
Q602	P-ANT SW	
Q603	P-ANT SW	
Q604	P-CON SW	
Q605	P-CON PROTECT	
Q606	P-CON PROTECT	
Q607	P-CON SW	
Q608	DIMMER SW	
Q609	EXT AMPCON SW	
Q611,612	PNL5V AVR	5V panel power supply
Q613,614	BU5V AVR	5V uCOM power supply
Q615,616	DD-CONV SW	
Q617,618	DD-CONV AVR	DC/DC converter power supply
Q619,620	SURVO7.5V AVR	7.5V CD mechanism power supply
Q621,622	AUDIO8V AVR	8V Audio power supply
Q623	14V SW	8V Audio, 5 V DSP, 7.5 V SERVO
Q624	14V SW	8V Audio, 5 V DSP, 7.5 V SERVO
Q632,633	AUDIO DC/DC 11V AVR	11V Audio DC/DC CONV power supply
Q801-803	AUDIO -9V SW	
Q804,805	AUDIO 9V SW	
Q806	AUDIO 9V SW	
Q900	LED SW	LED SW for SRC and KENWOOD logos
Q930,931	PNL5V SW	5V Panel SW for SA-BPF and REMOTE-CON
Q960	BK SW	
Q961,962	VFD SW	

KDC-Z727,Z727

MICROCOMPUTER'S TERMINAL DESCRIPTION

● System Microcomputer UPD703033GC060 (IC1 : Main unit)

PinNo.	Pin name	I/O	Description	Processing Operation
1	AMP_MUTE	O	Muting control output to Power IC	Muting ON: Low. Muting OFF: High.
2	AMP_STBY	O	Standby control output to Power IC	Standby canceled: High. Standby mode: Low.
3	NC	O	Output open	
4	NC	O	Output open	
5	P_ANT	O	Power antenna control output	Radio mode: High. Other mode: Low.
6	EVdd		Connected to B-U 5 V	
7	EVss		Connected to GND	
8	P_CONT	O	Power control output	ON: High. OFF: Low.
9	BEEP	O	Beep output	Permanently "L".
10	EXT_AMP	O	External amp control output	
11	DIMMER	I	Dimmer detection input	Dimmer ON: Low. Dimmer OFF: High.
12	CH_CON	O	CD-CH control output	ON: High. OFF: Low.
13	CH_REQH	O	CD-CH send request output	Request: Low.
14	DSP_DATA	O	Data output to DSP_IC (M65849BFP)	
15	DSP_STB	O	Strobe output to DSP_IC (M65849BFP)	
16	DSP_CLK	O	Clock output to DSP_IC (M65849BFP)	
17	NC	O	Output open.	
18	IC/Vpp	0	Test	
19	IN_SEL	O	CD/CD-CH switching control output	CD: Low. CD-CH: High. Other source: L.
20	SA_MUTE	O	Signal muting output to spectrum analyzer	MUTE ON:HI
21	I2C_SDA	I/O	Data input/output from/to CD mechanism, E-VOL (TDA7407) and HPF	
22	I2C_SCK	I/O	Clock output to CD mechanism, E-VOL (TDA7407) and HPF	
23	MUTE	O	Muting control output (N-CH open drain)	MUTE ON:HI, MUTE OFF:LO
24	SW5V	O	5 V SW control output (N-CH open drain)	SW5V ON:LO, SW5V OFF:HI
25	F/E_DATA	I/O	Data input/output from/to F/E and PROM (N-CH open drain)	
26	F/E_CLK	I/O	Clock output to F/E and PROM (N-CH open drain)	
27	PRE_OUT_MUTE	O	PRE-OUT muting control output	Muting ON: Low. Muting OFF: High. Momentary power down: Low.
28	IFC	I	IF_COUNT input from F/E	Station detected: Low. Station not detected: High.
29	AM+B	O	AM power supply control output	AM ON:HI, AM OFF:LO
30	FM+B	O	FM power supply control output	FM ON:HI, FM OFF:LO
31	RESET	I	Reset input	LO:RESET ON
32	XT1		Connected to Sub X'tal	
33	XT2		Connected to Sub X'tal	
34	REGC		1 uF connected to GND.	
35	X2		Connected to Main X'tal	
36	X1		Connected to Main X'tal	
37	Vss		Connected to GND	
38	Vdd		Connected to B-U 5 V	
39	CLKOUT		Open	
40	NC	O	Output open.	
41	NC	O	Output open.	
42	P_ON	O	Internal power supply control	ON:HI, OFF:LO
43	VFD_ON	O	VFD power supply control output	VFD ON:HI, VFD OFF:LO
44	NC	O	Output open.	
45	PNL5V	O	5 V panel control output	PNL 5 V ON: High. PNL 5 V OFF: Low. Panel detached:Low. Momentary power down: Low.

KDC-Z727,Z727

MICROCOMPUTER'S TERMINAL DESCRIPTION

PinNo.	Pin name	I/O	Description	Processing Operation
46	NC	O		
47	PNL_DET	I	Panel position detection input	Panel open (SW ON): Low. Panel closed (SW OFF): High.
48	CD_MUTE	I	Muting input from CD mechanism	MUTE:LO
49	CD_MRST	O	Reset output to CD mechanism	RESET:LO
50	CD_MSTOP	O	Stop request to CD mechanism	STOP:LO
51	CD_LO/EJ	I/O	CD mechanism loading motor control (Load/Eject)	LOAD:LO EJ:HI
52	CD_LMON	O	CD mechanism loading motor control (ON/OFF)	LOAD:LO EJ:HI
53	CD_SW3	I	Input from CD mechanism SW3 (DOWN_SW input)	ON:HI
54	NC	O	Output open.	
55	BVdd		Connected to B-U 5 V	
56	BVss		Connected to GND	
57	DSI	O	DSI LED control output	Panel detached: ON. Panel attached: OFF.
58-64	NC	O	Output open.	
65	PN_MC_REQ/PANEL	I/O	Send request output to Panel uCOM/Panel detection input	Panel detection input. Panel ON: Low.
66	PAN_RST	O	Reset control output to Panel uCOM	Same function as PNL 5 V.
67	LED_SW	O	LED control output for EJECT SW and DISC _OUTPUT open.	ILL ON:HI, ILL OFF:LO
68,69		O	Output open.	
70	AVCONT	O	A/D reference voltage control output	During operation: High.
71	AVdd		Connected to B-U 5 V	
72	AVss		Connected to GND	
73	AVref		A/D reference voltage	
74	PHONE	I	PHONE detection input	TEL muting: 1 V or less. NAVI muting: 2,5 V or more.
75-78	NC	I	Resistor connected to GND	
79	MP3/CD	I	MP3/CD identification input	CD: Low. MP3: High.
80	S-METER	I	FM S-meter input from F/E	(Analog input)
81	TYPE1	I	Destination type ID input	K (North America); H. M (General overseas); L
82	TYPE2	I	Destination type ID input	K (North America); H. M (General overseas); H
83	NC	I	Resistor connected to GND	
84	ST_TYPE1	I	E-VOL setting selection input	Normal: Low. Special: High.
85	ST_TYPE2	I	E-VOL setting selection input	Normal: Low. Special: High.
86	NC	O	Output open.	
87	DISC_EJ_SW	I	CD EJECT SW input (Interrupt input)	CD ejection: Low. (Interrupt input)
88	CH_REQC	I	Send request input from CD-CH (Interrupt input)	ON: Low. (Interrupt input)
89	PN_SC_REQ	I	Send request from Panel uCOM	(Interrupt input)
90	CD_SW1	I	Input from CD_SW1 (Loading SW detection)	LO:ON, HI:OFF
91	CD_SW2	I	Input from CD_SW2 (12 cm CD detection)	LO:ON, HI:OFF
92	ACC_DET	I	Acc detection input	HI:ACC OFF, LO:ACC ON
93	BU_DET	I	B-U detection input (Interrupt input)	B-U power down: High. B-U normal: Low. Muting and mechanism operation stop should be executed quickly. (Interrupt input)
94	CH_DATA_C	I	Data input from CD-CH	
95	CH_DATA_H	O	Data output to CD-CH	
96	CH_CLK	I/O	Clock input/output from/to CD-CH	
97	PN_SC_DATA	I	Data input from Panel uCOM	
98	PN_MC_DATA	I/O	Data output to Panel uCOM	
99	PN_MC_CLK	O	Clock output to Panel uCOM	
100	NC	O	OUTPUT OPEN	

KDC-Z727,Z727

MICROCOMPUTER'S TERMINAL DESCRIPTION

● Panel Microcomputer UPD703033GC062 (IC900 : Control uCOM)

PinNo.	Pin name	I/O	Description	Processing Operation
1	VFD_DATA1	O	Data output "1" to VFD driver	
2	VFD_CLK	O	Clock output to VFD driver	
3	NC	I	Resistor connected to GND	
4	VFD_DATA2	O	Data output "2" to VFD driver	
5	VFD_CLK_IN	I	Clock input from VFD_CLK (For use in synchronization of DATA 1 and 2)	
6	EVdd		Connected to PNL 5 V	
7	EVss		Connected to GND	
8	NC	O	Output open.	
9	5V_ON	O	Power supply control output to Remote Control IC and SA_IC.	5V ON:HI, 5V OFF:LO
10	REMO	I	Remote control signal input	
11	NC	O	Output open.	
12	VFD_LATCH	O	Latch output to VFD driver	
13	VFD_GCP	O	Luminance gradation control output to VFD driver	
14	A13	O	Address output "A13" to external ROM	
15	A14	O	Address output "A14" to external ROM	
16	A15	O	Address output "A15" to external ROM	
17	VFD_BLK	O	Blank output to VFD driver	Display ON: High. Display OFF: Low.
18	IC/Vpp		Test	
19	A5	O	Address output "A5" to external ROM	
20	A6	O	Address output "A6" to external ROM	
21	A7	O	Address output "A7" to external ROM	
22	A8	O	Address output "A8" to external ROM	
23	A9	O	Address output "A9" to external ROM	
24	A10	O	Address output "A10" to external ROM	
25	A11	O	Address output "A11" to external ROM	
26	A12	O	Address output "A12" to external ROM	
27	A1	O	Address output "A1" to external ROM	
28	A2	O	Address output "A2" to external ROM	
29	A3	O	Address output "A3" to external ROM	
30	A4	O	Address output "A4" to external ROM	
31	RESET	I	Reset input	
32	XT1		Resistor connected to GND	
33	XT2		OPEN	
34	REGC		1 uF connected to GND	
35	X2		Connected to Main X'tal	
36	X1		Connected to Main X'tal	
37	Vss		Connected to GND	
38	Vdd		Connected to PNL 5 V	
39	CLKOUT		OPEN	
40	NC	O	OUTPUT OPEN	
41	NC	O	OUTPUT OPEN	

KDC-Z727,Z727

MICROCOMPUTER'S TERMINAL DESCRIPTION

PinNo.	Pin name	I/O	Description	Processing Operation
42	NC	O	OUTPUT OPEN	
43	OE	O	Output Enable output to external ROM	
44	CE	O	Chip Enable output to external ROM	
45	NC	O	OUTPUT OPEN	
46	NC	O	OUTPUT OPEN	
47	AD0	I	Data input "AD0" from external ROM	
48	AD1	I	Data input "AD1" from external ROM	
49	AD2	I	Data input "AD2" from external ROM	
50	AD3	I	Data input "AD3" from external ROM	
51	AD4	I	Data input "AD4" from external ROM	
52	AD5	I	Data input "AD5" from external ROM	
53	AD6	I	Data input "AD6" from external ROM	
54	AD7	I	Data input "AD7" from external ROM	
55	BVdd		Connected to PNL 5 V	
56	BVss		Connected to GND	
57	AD8	I	Data input "AD8" from external ROM	
58	AD9	I	Data input "AD9" from external ROM	
59	AD10	I	Data input "AD10" from external ROM	
60	AD11	I	Data input "AD11" from external ROM	
61	AD12	I	Data input "AD12" from external ROM	
62	AD13	I	Data input "AD13" from external ROM	
63	AD14	I	Data input "AD14" from external ROM	
64	AD15	I	Data input "AD15" from external ROM	
65	A16	O	Address output "A16" to external ROM	
66	A17	O	Address output "A17" to external ROM	
67	A18	O	Address output "A18" to external ROM	
68	A19	O	Address output "A19" to external ROM	
69	NC	O	OUTPUT OPEN	
70	A21	O	Address output "A21" to external ROM	
71	AVdd		Connected to PNL 5 V	
72	AVss		Connected to GND	
73	AVref			
74	SA_F01	I	Spectrum analyzer signal input (63Hz)	
75	SA_F02	I	Spectrum analyzer signal input (150Hz)	
76	SA_F03	I	Spectrum analyzer signal input (330Hz)	
77	SA_F04	I	Spectrum analyzer signal input (1KHz)	
78	SA_F05	I	Spectrum analyzer signal input (3.3KHz)	
79	SA_F06	I	Spectrum analyzer signal input (10KHz)	
80	LEVEL_M	I	MIX signal input for level meter	
81	KR5	I	Key return "5"	
82	KR4	I	Key return "4"	

KDC-Z727,Z727

MICROCOMPUTER'S TERMINAL DESCRIPTION

PinNo.	Pin name	I/O	Description	Processing Operation
83	KR3	I	Key return "3"	
84	KR2	I	Key return "2"	
85	KR1	I	Key return "1"	
86	PN_SC_REQ	O	Send request output to Main uCOM	
87	AVCONT	O	A/D reference voltage control output	Operating: High.
88	PN_SC_CON	I	Operation control input from Main uCOM	Operating: High. (Interrupt input)
89	NC	O	Output open.	
90	SOURCE	I	SRC key input	ON: High. OFF: Low. (Interrupt input)
91	BLUE	O	Blue LED control output	LED ON:HI, LED OFF:LO
92	PN_MC_REQ	I	Send request input from Main uCOM	
93	KS4	O	Key scan "4"	
94	KS3	O	Key scan "3" and Flash uCOM write port	
95	KS2	O	Key scan "2" and Flash uCOM write port	
96	KS1	O	Key scan "1" and Flash uCOM write port	
97	PN_SC_DATA	I	Data input from Main uCOM	
98	PN_MC_DATA	O	Data output to Main uCOM	
99	PN_MC_CLK	I	Clock input from Main uCOM	
100	NC	I	Resistor connected to GND	

KDC-Z727,Z727

TEST MODE

System Microcomputer Test Mode

(1) How to enter the test mode

While holding the EQ and ATT keys with All OFF, press the SRC key.

(2) How to exit from the test mode

Reset the unit.

(Note) The test mode cannot be terminated by Acc OFF, power OFF or momentary power down.

(3) Initial condition in the test mode

- Source: All OFF.
- Display: All ON.
- Volume: -10 dB (displayed as "30").
- LOUD: OFF.
- CRSC: OFF regardless of whether or not the switching function is provided.
- SYSTEM Q: Flat.

(4) Special display in TUNER mode

If any of the following messages are displayed in TUNER mode, the front end or other part may be abnormal.

- "TNE2P NG": The EEPROM remains in the initial value (undefined values) because the F/E was shipped without passing the adjustment process, etc.
- "TNCON NG": Communication with the F/E is not available.

(5) CD receiver test mode specifications

- Forced ejection at reset start is inhibited. The CD is not recognized when the set is reset with the CD loaded in it.
- Pressing the Track Up key jumps to the following tracks in cycle: No. 9→No. 15→No. 10→No. 11→No. 12→No. 13→No. 14→No. 9 (return to the beginning)
- Pressing the Track Down key jumps to the previous track to the track being played.

(6) Audio specifications

- A short press (tapping) of the Q key initiates the audio adjustment mode.
- Pressing the * key on the remote initiates the audio adjustment mode.
- Successive press of the remote key is inhibited.
- Bass, Middle and Treble can be adjusted in 3 steps of MIN, Center and MAX with the Track Up/Down keys.
- Balance can be adjusted in 3 steps of Left MAX, Center and Right MAX with the Track Up/Down keys.
- Fader can be adjusted in 3 steps of Rear MAX, Center and Front MAX with the Track Up/Down keys.
- HPF can be adjusted in 2 steps of Through and 220 Hz with the Track Up/Down keys:
- LPF can be adjusted in 2 steps of Through and 120 Hz with the Track Up/Down keys.
- Bass F, Bass Q, Bass EXT, Middle F, Middle Q and Treble F are not dealt with in the audio adjustment mode.

(7) Menu specifications

- Pressing the DNPP/SBF key on the remote initiates the Menu mode.
- Successive press of the remote key is inhibited.
- The calendar adjustment and calendar display switching is eliminated.

(8) Back-Up current measurement

- When the set is reset with Acc OFF (when the Back-Up current is turned ON), the MUTE terminal goes OFF in 2 seconds instead of 15 seconds.
- When Acc is turned OFF in the test mode, the MUTE terminal goes OFF in 2 seconds instead of 15 seconds. The CD/MD mechanisms are not activated at this time.

(9) Special display when display is All ON

Pressing one of the PRESET keys while all display is ON in the All OFF mode displays the information as shown below.

[PRESET1]	Version display (8 digits, Month/Day/Hour/Minute) (Display) YS xxxxxxxx System microcomputer PAN xxxxxxxx Panel microcomputer
[PRESET2]	Serial No. display (8 digits) (Note) The display is not compatible with MSG. (Display) SNo. xxxxxxxx
[PRESET3]	Short press: Display power ON time (The All OFF time is not counted.) Long press: Clear power ON time (Display) Pon Tim xxxxx Max. 65535 (hr)
[PRESET4]	Short press: Display CD/MD operating time Long press: Clear CD/MD operating time (Display) CD Time xxxxx (CD/R, MP3/R) MD Time xxxxx (MD/R) Max. 65535 (hr)
[PRESET5]	Short press: Display CD/MD ejection count Long press: Clear CD/ME ejection count (Display) Eje Tim xxxxx Max. 65535 (times)
[PRESET6]	Short press: Display open/close count Long press: Clear open/close count (Display) PnCnt xxxxxx Max. 655350 (times)

(10) Other

- Messages such as "CODE OFF" are not displayed at power ON.
- Pressing the TI (AUTO) key during the changer operation turns ON 2zone, which can be turned OFF also with the TI (AUTO) key. The P/S dot lights while 2zone is ON.

■ Security specifications

- Forced power ON mode (All models) Even when the security mode is permitted, the power can be turned ON for only 30 minutes by pressing the SRC key while holding the ATT and PRESET 4 keys depressed. After 30 minutes have elapsed, the set can be restored only by resetting it.
- Method of security code registration after EEPROM (F/E) replacement (Code security models)
 1. Enter the test mode. (See "(1) How to enter the test mode".)
 2. Press the CLK key to enter the security registration mode.
 3. Enter the code by pressing the PRESET 1/2/3/4 keys.
Example: To enter "3510"
 - Press the PRESET 1 key 4 times.
 - Press the PRESET 2 key 6 times.
 - Press the PRESET 3 key 2 times.
 - Press the PRESET 4 key once.
 4. Press and hold the DISP key for 3 seconds until "APPROVED" is displayed.
 5. Exit from the test mode. (See "(2) How to exit from the test mode".)
(Note) The security code of these models cannot be subjected to the All Clear operation.
- Method of clearing the simplified security code (K Type only)
 1. While holding the DISP key during the code request mode, press and hold the VOL Up key for 3 seconds (until "----" disappears).
 2. Enter "KCAR" from the remote. (Same as the 00 model) Press the "5" key on the remote 2 times then press the Track Up key. (This enters "K".)
Press the "2" key on the remote 3 times then press the Track Up key. (This enters "C".)
Press the "2" key on the remote once then press the Track Up key. (This enters "A".)
Press the "7" key on the remote 2 times then press the Track Up key. (This enters "R".)
 3. The security mode is exited and the set enters the All OFF mode.
 4. If an erroneous code is entered, the set enters the code request mode again.

PC BOARD (COMPONENT SIDE VIEW)

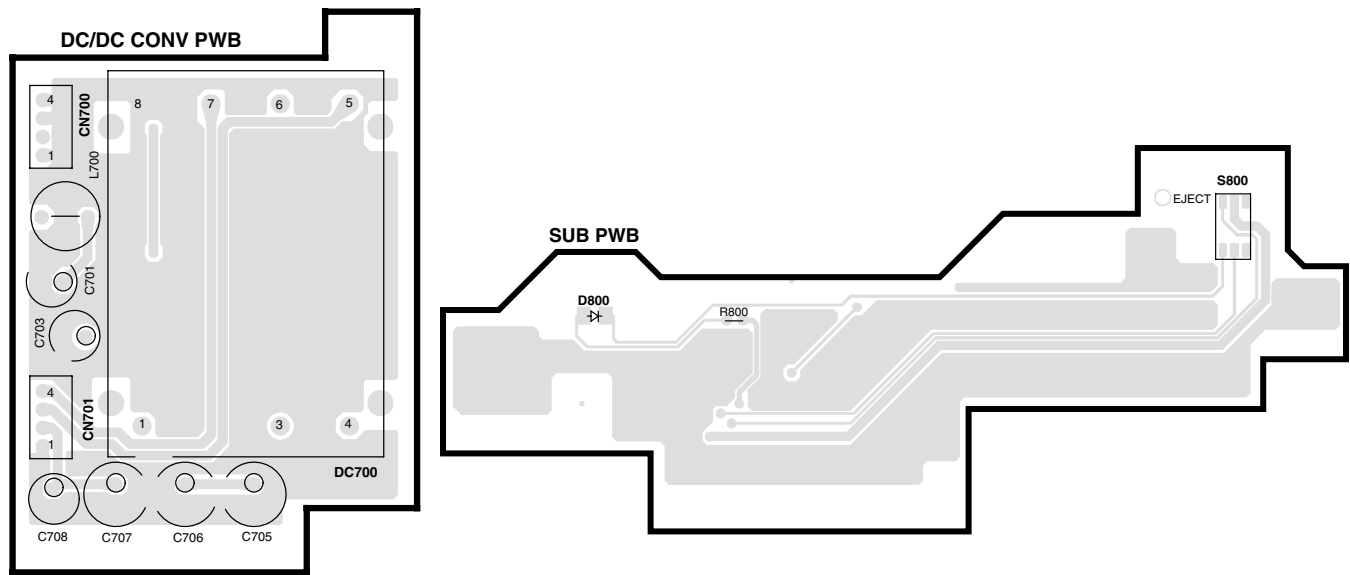

(FOIL SIDE VIEW)

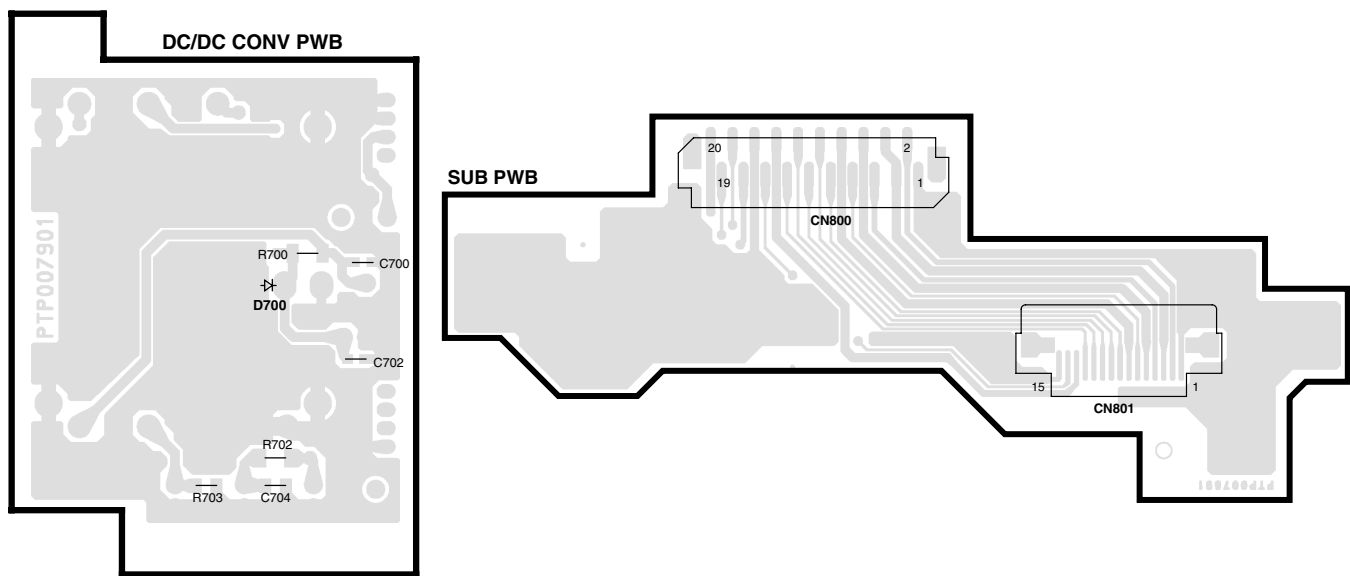

PC BOARD (COMPONENT SIDE VIEW)

X32-5030-01 (J74-1161-02)

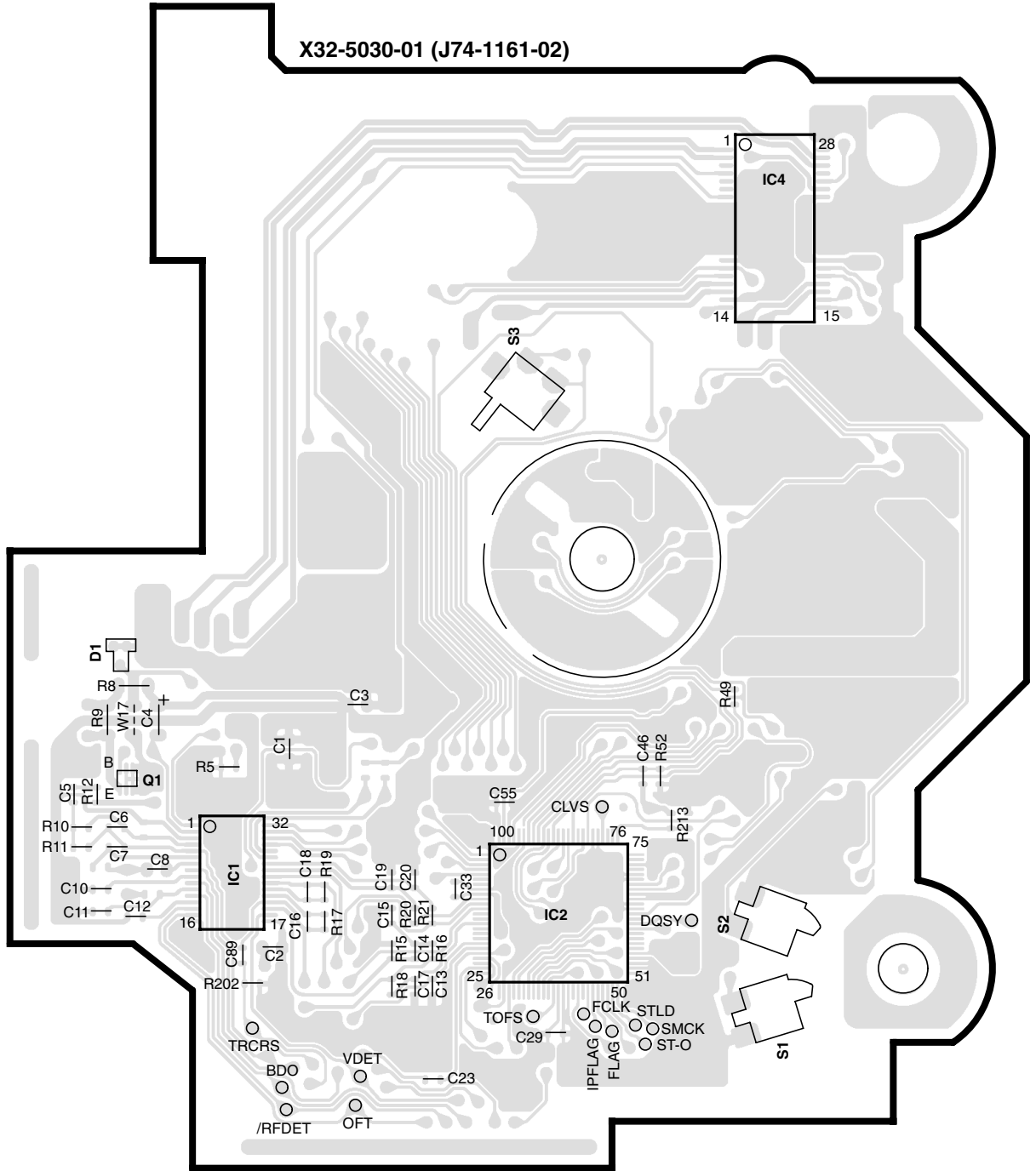

X32-5030-01

IC	1	2	4
Q			1
address	5G	5H	2I 5G

(FOIL SIDE VIEW)

X32-5030-01 (J74-1161-02)

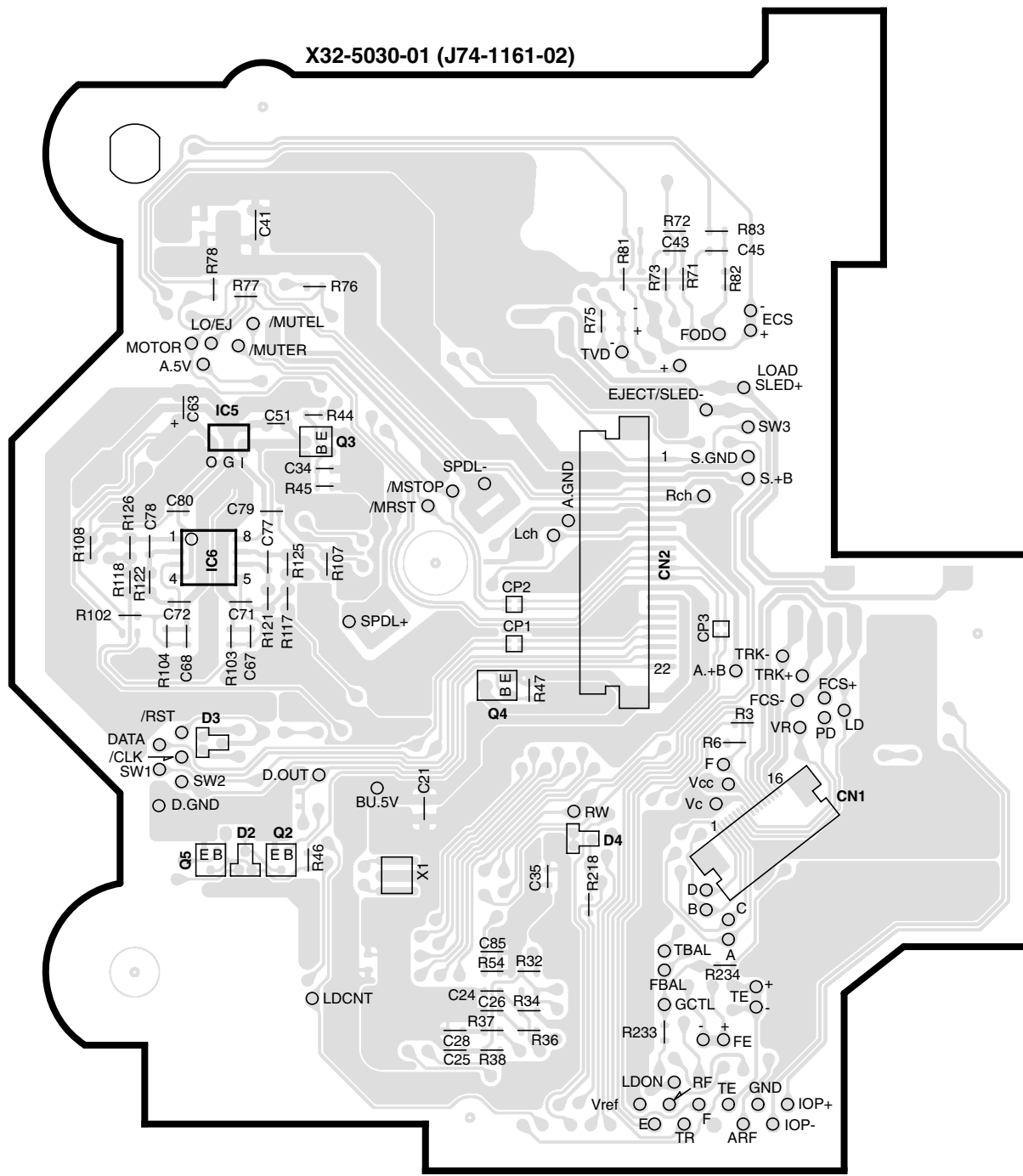

X32-5030-01

IC	5	6				
Q		2	3	4	5	
address	2L	4L	5L	3L	4M	5L

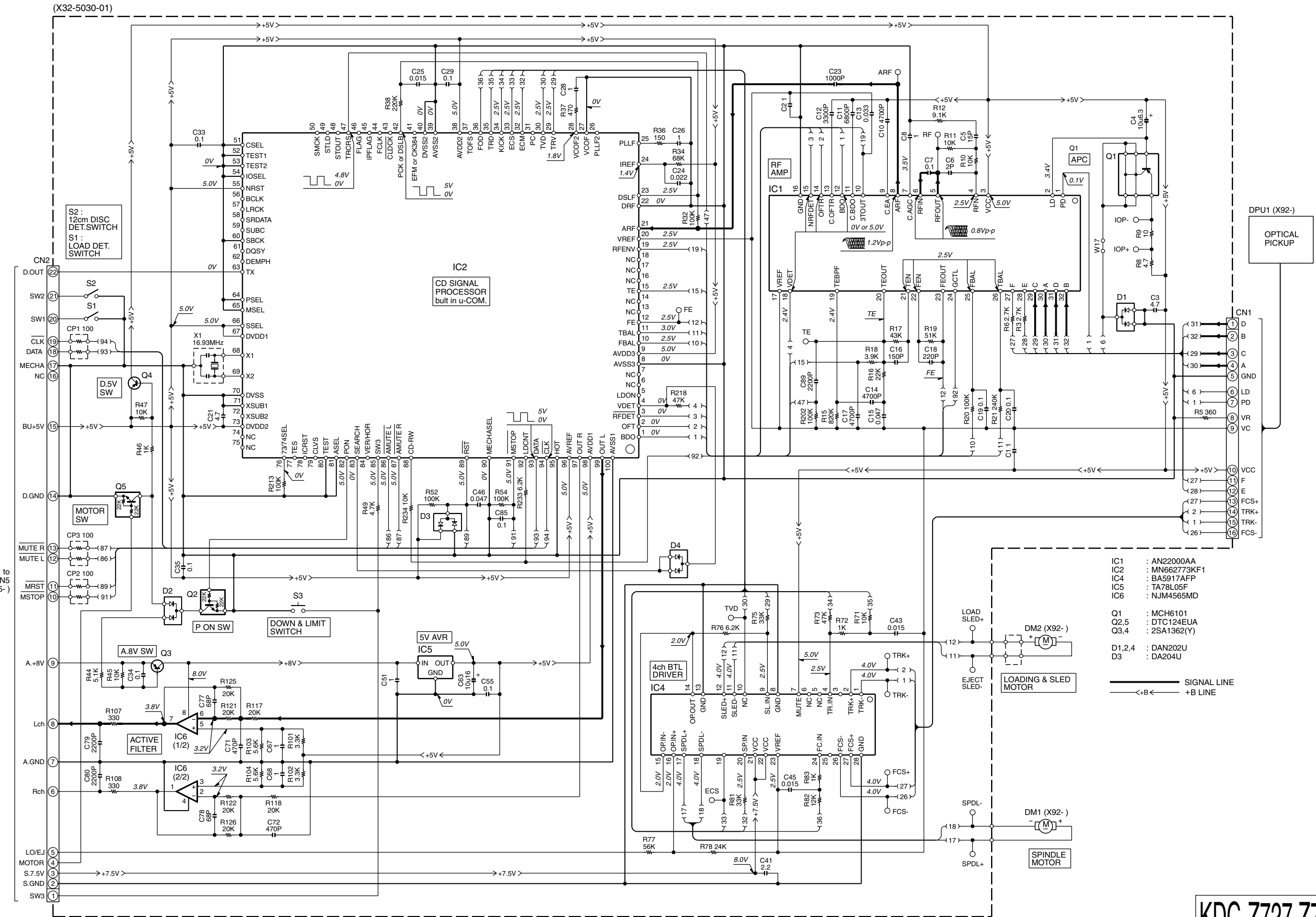

- IC1 : AN22000AA
- IC2 : MN662773KF1
- IC4 : BA5917AFP
- IC5 : TA78L05F
- IC6 : NJM4565MD
- Q1 : MCH6101
- Q2,5 : DTC124EUA
- Q3,4 : 2SA1362(Y)
- D1,2,4 : DAN202U
- D3 : DA204U

— SIGNAL LINE
 <-B- +B LINE

CAUTION : For continued safety, replace safety critical components only with manufacturer's recommended parts (refer to parts list).
 ▲ Indicates safety critical components. To reduce the risk of electric shock, leakage-current or resistance measurements shall be

carried out (exposed parts are acceptably insulated from the supply circuit) before the appliance is returned to the customer.
 • DC voltages are as measured with a high impedance voltmeter. Values may vary slightly due to variations between individual instruments or/and units.



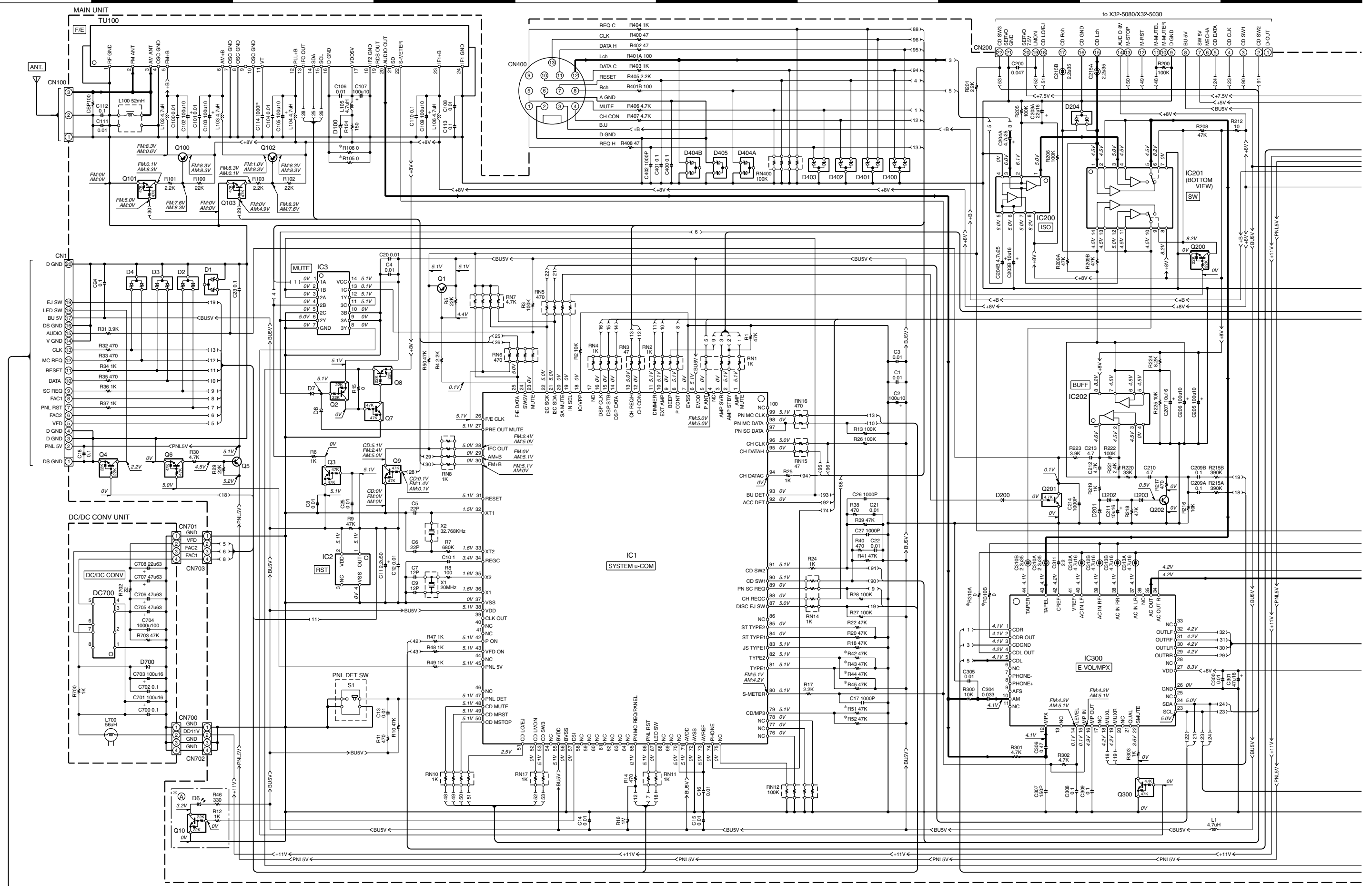

- | | | | | | | | | | | | | | | |
|---------|---|---------|--------|--------|--------|---|-----|-----------|---------|----------|-----------------------|-------|---------|---------|
| 2SB1565 | DTA144EUA
DTC114YUA
DTC343TK
2SA1362
2SA1576A | 2SB1132 | 2SB118 | 2SB144 | 2SC408 | DTA144EUA
DTA124EUA
DTC114EUA
DTC124EUA
DTC144EUA | OUT | NJM4565MD | DAN202U | TA78L05F | DAP202
U
DA2Q4U | DA227 | BA3129F | BA3830F |
| | | | | | | | | | | | | | | |

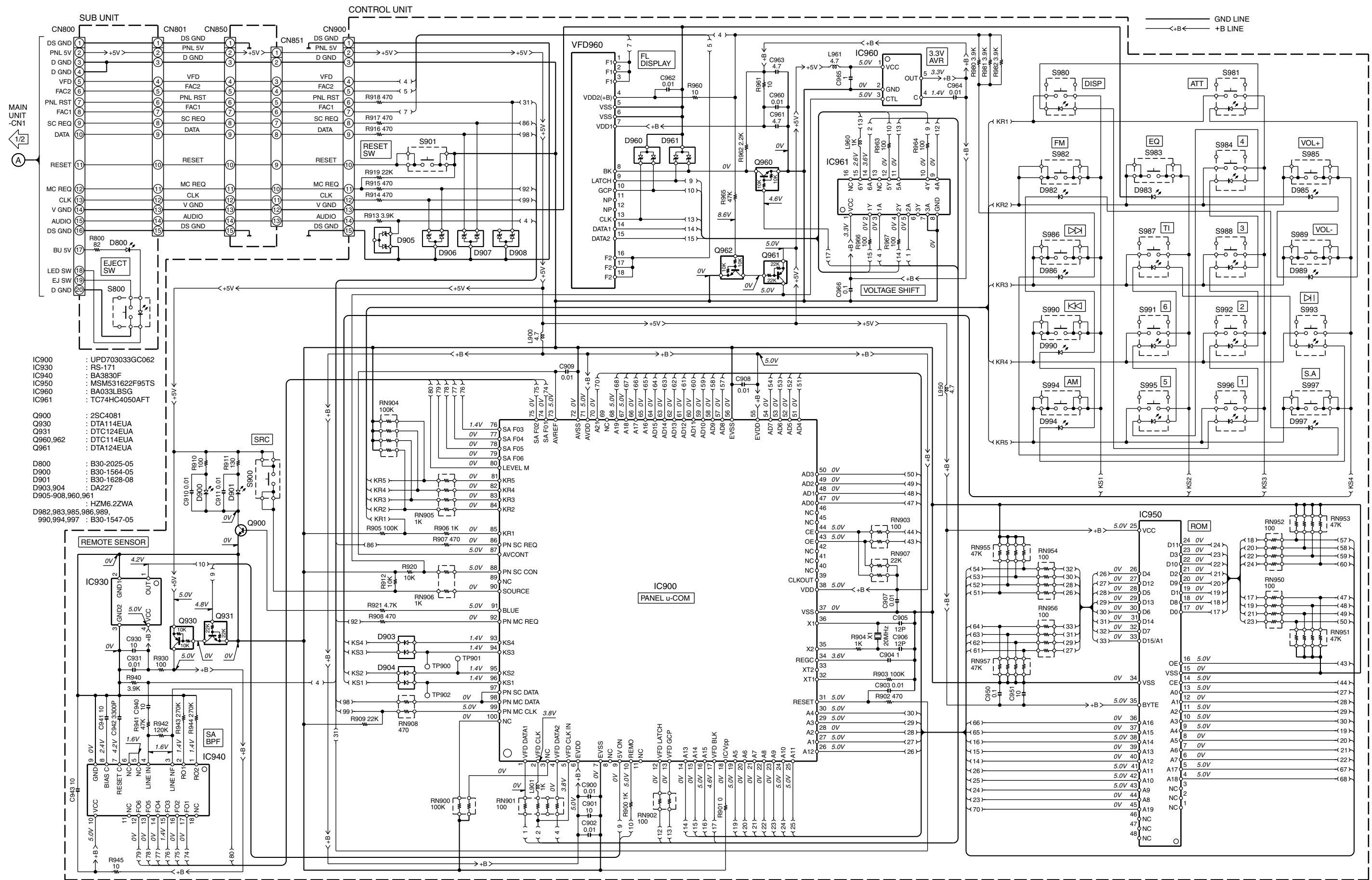

- IC900 : UPD703033GC062
 IC930 : RS-171
 IC940 : BA3830F
 IC950 : MSM531622F95TS
 IC960 : BA033LBSG
 IC961 : TC74HC4050AFT
- Q900 : 2SC4081
 Q930 : DTA114EUA
 Q931 : DTC124EUA
 Q960,962 : DTC114EUA
 Q961 : DTA124EUA
- D800 : B30-2025-05
 D900 : B30-1564-05
 D901 : B30-1628-08
 D903,904 : DA227
 D905-908,960,961 : HZM6.2ZWA
 D982,983,985,986,989,990,994,997 : B30-1547-05

CAUTION : For continued safety, replace safety critical components only with manufacturer's recommended parts (refer to parts list).

△ Indicates safety critical components. To reduce the risk of electric shock, leakage-current or resistance measurements shall be carried out (exposed parts are acceptably insulated from the supply circuit) before the appliance is returned to the customer.

- DC voltages are as measured with a high impedance voltmeter. Values may vary slightly due to variations between individual instruments or/and units.

KDC-Z727,Z727

EXPLODED VIEW (MECHANISM)

- | | | | |
|---|-------------|---|-------------|
| A | M1.7x2.5 | : | N09-4249-05 |
| B | ∅2x3.5 | : | N09-4172-05 |
| C | M1.7x4 | : | N09-4202-05 |
| D | M2x2 | : | N38-2020-46 |
| E | ∅2x6 | : | N09-4294-05 |
| F | WASHER ∅1.2 | : | N19-2023-04 |
| G | WASHER ∅1.6 | : | N19-2058-04 |
| H | WASHER ∅1.6 | : | N19-2093-04 |
| J | M2x2 | : | N39-2020-46 |

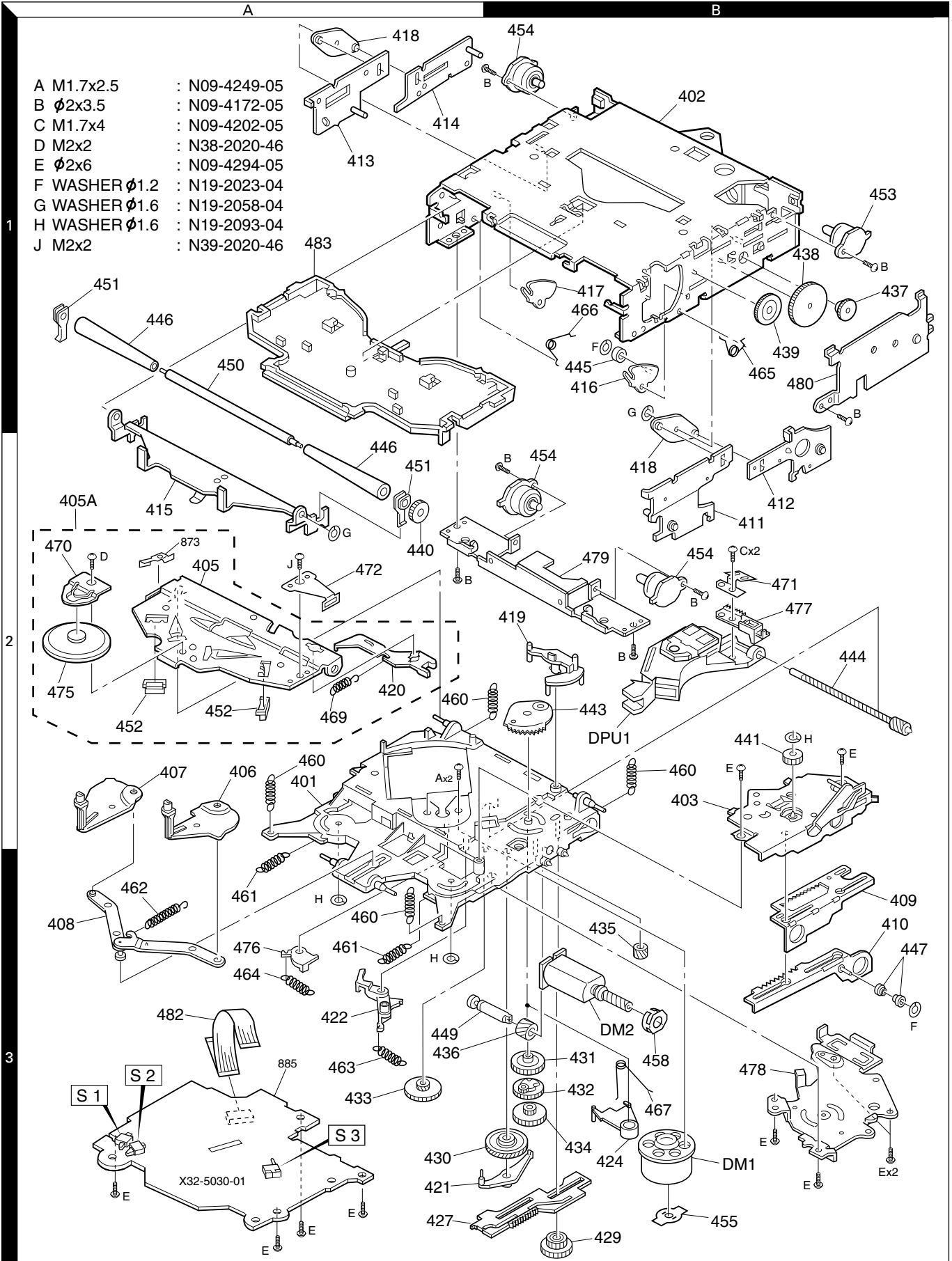

Parts with the exploded numbers larger than 700 are not supplied.

KDC-Z727,Z727

PARTS LIST

* New Parts

Parts without **Parts No.** are not supplied.

Les articles non mentionnes dans le **Parts No.** ne sont pas fournis.

Teile ohne **Parts No.** werden nicht geliefert.

Ref. No.	A d d	N e w	Parts No.	Description	Dest inati on
KDC-Z727/Z727					
200	1C	*	A02-2711-08	PLASTIC CABINET ASSY	
201	2C	*	A22-2928-08	SUB PANEL ASSY	M
201	2C	*	A22-2936-08	SUB PANEL ASSY	K
203	3C	*	A46-1744-08	REAR COVER	
204	1D	*	A52-0800-08	TOP PLATE	
PA1	3C	*	A64-2473-08	PANEL(FRONT)ASSY	M
PA1	3C	*	A64-2625-08	PANEL(FRONT)ASSY	K
RM1	1C	*	A70-0894-05	REMOTE CONTROLLER ASSY(RC-520)	
205	3C	*	B07-3038-08	ESCUTCHEON	M
205	3C	*	B07-3048-08	ESCUTCHEON	K
206	3C	*	B07-3036-08	DECORATION(SRC)ASSY	
207	3C	*	B10-4203-08	FRONT GLASS ASSY	K
207	3C	*	B10-4204-08	FRONT GLASS ASSY	M
208	3C	*	B19-2126-08	LIGHTING BOARD	
-			B46-0100-50	WARRANTY CARD	
-			B46-0606-04	ID CARD	K
-			B46-0612-14	ID CARD	M
-		*	B64-2011-00	INSTRUCTION MANUAL (ENGLISH)	K
-		*	B64-2012-00	INSTRUCTION MANUAL (ENG.CHI.)	M
-		*	B64-2013-00	INSTRUCTION MANUAL (FRE.SPA.)	K
209	1C	*	D10-4364-08	LEVER (KEY)	
210	2C	*	D10-4634-08	ARM	
211	2C	*	D10-4635-08	LEVER ASSY	
212	1C	*	D10-4637-08	ARM ASSY (L)	
213	2C	*	D10-4639-08	LEVER (RELEASE)	
214	2C	*	D10-4640-08	LEVER (SW)	
215	3C	*	D10-4641-08	LEVER LOCK ASSY	
216	2C	*	D13-2218-08	GEAR (B)	
217	2C	*	D13-2219-08	GEAR (A)	
218	1C	*	D21-2397-08	SHAFT (SW)	
DC1	1C	*	E30-6021-08	DC CORD ASSY	
FC1	1D	*	E39-0432-08	22P FLAT CABLE	
220	2C	*	F07-1100-08	COVER (FLEX)	
221	3C	*	F07-1101-08	COVER (LOCK)	
222	2C	*	F07-1102-08	COVER (CONNECTOR)	
223	2C	*	F09-1712-08	SHEET,PROTECT (B)	
224	2C	*	F09-1713-08	SHEET,PROTECT (A)	
225	2D	*	F09-1721-08	SHEET (DC/DC)	
227	3C	*	F10-1865-08	DISCHARGE PLATE	
229	2D	*	F29-0049-05	INSULATING COVER	
230	2C	*	G09-2043-08	SPRING	
231	1C	*	G09-2044-08	SPRING (RELEASE)	
232	2C	*	G09-2045-08	SPRING (SW)	
233	3C	*	G09-2046-08	SPRING	
234	2C	*	G09-2047-08	SPRING (MAIN)	
235	3C	*	G09-2048-08	SPRING (OPEN)	
236	2C	*	G13-1252-08	CUSHION (SUB)	
237	3C	*	G13-1253-08	CUSHION (KNOB)	
-		*	H10-4790-08	POLYSTYRENE FOAMED FIXTURE	
-		*	H25-0337-04	POLY BAG (04X200X290)	
-		*	H25-1171-08	PROTECTION BAG (03X270X550)	

Ref. No.	A d d	N e w	Parts No.	Description	Dest inati on
-		*	H54-2159-08	ITEM CARTON CASE	K
-		*	H54-2160-08	ITEM CARTON CASE	M
240	2C	*	J19-5108-08	HOLDER (LEVER)	
241	2C	*	J19-5109-08	BRACKET ASSY	
242	3C	*	J19-5112-08	PLATE,HOLDER	
243	2C	*	J19-5113-08	HOLDER (SPRING)	
244	2C	*	J19-5114-08	HOLDER (PANEL)	
245	2C	*	J19-5122-08	ROTARY DAMPER	
246	2C	*	J19-5123-08	HOLDER ASSY	
247	1C	*	J21-9585-18	MOUNTING HARDWARE ASSY	
248	1C	*	J54-0606-04	STAY	
FPC1	3C	*	J84-0138-08	FLEXIBLE PWB ASSY	
251	2C	*	K24-3795-08	KNOB (EJECT)	
252	3C	*	K24-3796-08	KNOB (RELEASE)	
252	3C	*	K24-3834-08	KNOB (RELEASE)	K
253	3C	*	K24-3797-08	KNOB (RESET)	
254	3C	*	K24-3798-08	KNOB (SRC)	
255	3C	*	K24-3833-08	KNOB (EQ)	
256	3C	*	K24-3800-08	KNOB (SA)	
257	3C	*	K24-3801-08	KNOB (ATT)	
258	3C	*	K24-3802-08	KNOB (FF)	
259	3C	*	K24-3803-08	KNOB (REW)	
260	3C	*	K25-1369-08	KNOB (VOL)	
261	3C	*	K25-1370-08	KNOB (AM/FM)	
262	3C	*	K25-1371-08	KNOB (PRESET)	
264	1C	*	N99-1716-08	SCREW SET	
265	1C	*	N99-1700-05	SCREW SET	
A	2C	*	N09-4491-08	MACHINE SCREW	
B	2C	*	N09-4498-08	MACHINE SCREW	
C	2C	*	N09-4499-08	MACHINE SCREW	
D	2C	*	N09-4500-08	MACHINE SCREW	
F	2C	*	N09-6002-08	MACHINE SCREW	
G	2C	*	N09-6003-08	MACHINE SCREW	
H	2C	*	N19-2164-08	FLAT WASHER	
J	2C	*	N19-2165-08	FLAT WASHER	
K	3D	*	N30-3004-46	PAN HEAD MACHINE SCREW	
L	2C	*	N35-2004-45	BINDING HEAD MACHINE SCREW	
N	3C	*	N82-2006-46	BINDING HEAD TAPTITE SCREW	
T	1D	*	N35-2004-46	BINDING HEAD MACHINE SCREW	
DME1	1D	*	X92-4190-01	CD MECHANISM ASSY	
MAIN UNIT					
D6			B30-1424-05	LED (CL-150SR)	
B600			C91-2134-08	ELECTRO 0.10F 5.5WV	
C1			CK73GB1H103K	CHIP C 0.010UF K	
C2			CE04CW1A101M	ELECTRO 100UF 10WV	
C3			CK73GB1H103K	CHIP C 0.010UF K	
C4			CK73GB1H103K	CHIP C 0.010UF K	
C5			CC73GCH1H220J	CHIP C 22PF J	
C6			CC73GCH1H220J	CHIP C 22PF J	
C7			CC73GCH1H120J	CHIP C 12PF J	
C8			CK73GB1H103K	CHIP C 0.010UF K	
C9			CC73GCH1H120J	CHIP C 12PF J	
C10			CK73GB0J105K	CHIP C 1.0UF K	

E: Europe K: North America M: Other Areas
W: Without Europe

K : Z727
M : KDC-Z727

△ indicates safety critical components.

KDC-Z727,Z727

PARTS LIST

*New Parts

Parts without **Parts No.** are not supplied.

Les articles non mentionnes dans le **Parts No.** ne sont pas fournis.

Teile ohne **Parts No.** werden nicht geliefert.

MAIN UNIT

Ref. No.	A d d	N e w	Parts No.	Description	Dest inati on
C11			C90-2610-05	ELECTRO 2.2UF 50WV	
C12 -16			CK73GB1H103K	CHIP C 0.010UF K	
C17			CK73GB1H102K	CHIP C 1000PF K	
C18			CK73GB1H104K	CHIP C 0.10UF K	
C20 -22			CK73GB1H103K	CHIP C 0.010UF K	
C23			CK73FB1C104K	CHIP C 0.10UF K	
C24			CK73FB1C104K	CHIP C 0.10UF K	
C25			CK73GB1H103K	CHIP C 0.010UF K	
C26			CK73GB1H102K	CHIP C 1000PF K	
C27			CK73GB1H102K	CHIP C 1000PF K	
C100			CK73GB1H103K	CHIP C 0.010UF K	
C101			CK73GB1H103K	CHIP C 0.010UF K	
C102			CE04CW1A101M	ELECTRO 100UF 10WV	
C103			CE04CW1A101M	ELECTRO 100UF 10WV	
C104			CK73GB1H103K	CHIP C 0.010UF K	
C105			CE04CW1A101M	ELECTRO 100UF 10WV	
C106			CK73GB1H103K	CHIP C 0.010UF K	
C107			CE04CW1A101M	ELECTRO 100UF 10WV	
C108			CK73GB1H103K	CHIP C 0.010UF K	
C109			CE04CW1A101M	ELECTRO 100UF 10WV	
C111			CK73GB1H103K	CHIP C 0.010UF K	
C112			CK73EB1E104K	CHIP C 0.10UF K	
C113			CK73GB1H104K	CHIP C 0.10UF K	
C200			CK73GB1H473K	CHIP C 0.047UF K	
C203A			CE04CW1C220M	ELECTRO 22UF 16WV	
C203B			C90-2597-05	ELECTRO 10UF 16WV	
C204A,B			CE04CW1V4R7M	ELECTRO 4.7UF 35WV	
C205			CE04CW1A101M	ELECTRO 100UF 10WV	
C206			CE04CW1A101M	ELECTRO 100UF 10WV	
C207			C90-2597-05	ELECTRO 10UF 16WV	
C209A,B			CK73GB1H104K	CHIP C 0.10UF K	
C210			CK73FF1A475Z	CHIP C 4.7UF Z	
C211			C90-2597-05	ELECTRO 10UF 16WV	
C212			CK73FF1A475Z	CHIP C 4.7UF Z	
C213			CK73FF1A475Z	CHIP C 4.7UF Z	
C214			CK73GB1H102K	CHIP C 1000PF K	
C215A,B			C90-2600-05	ELECTRO 2.2UF 35WV	
C300			CK73GB1H103K	CHIP C 0.010UF K	
C301			CE04CW1C470M	ELECTRO 47UF 16WV	
C302			CK73GB1H103K	CHIP C 0.010UF K	
C303			CE04CW1C470M	ELECTRO 47UF 16WV	
C304			CK73GB1H333K	CHIP C 0.033UF K	
C305			CK73GB1H103K	CHIP C 0.010UF K	
C306			CK73GB1A474K	CHIP C 0.47UF K	
C307			CC73FCH1H151J	CHIP C 150PF J	
C308			CK73GB1H104K	CHIP C 0.10UF K	
C309			CK73GB1H104K	CHIP C 0.10UF K	
C310A,B			C90-2600-05	ELECTRO 2.2UF 35WV	
C311			CK73FB1A225K	CHIP C 2.2UF K	
C312A,B			C90-2524-05	NP-ELEC 4.7UF 16WV	
C313A,B			C90-2524-05	NP-ELEC 4.7UF 16WV	
C315A,B			CK73GB1A334K	CHIP C 0.33UF K	
C316A,B			CK73GB1A334K	CHIP C 0.33UF K	
C317A,B			CK73GB1A224K	CHIP C 0.22UF K	
C318A,B			CK73GB1A224K	CHIP C 0.22UF K	

Ref. No.	A d d	N e w	Parts No.	Description	Dest inati on
C319			CK73FB1A225K	CHIP C 2.2UF K	
C320A,B			CK73FB1A225K	CHIP C 2.2UF K	
C321A,B			CK73GB1H104K	CHIP C 0.10UF K	
C322A,B			CK73GB1H104K	CHIP C 0.10UF K	
C350A,B			CE04CW1C220M	ELECTRO 22UF 16WV	M
C350A,B			C90-2597-05	ELECTRO 10UF 16WV	K
C351A,B			CE04CW1C220M	ELECTRO 22UF 16WV	M
C351A,B			C90-2597-05	ELECTRO 10UF 16WV	K
C352			CK73FB1C104K	CHIP C 0.10UF K	M
C353A,B			CK73FB1H222K	CHIP C 2200PF K	
C354A,B			CK73FB1H222K	CHIP C 2200PF K	
C355A,B			CE04CW1C220M	ELECTRO 22UF 16WV	M
C356A,B			CK73FB1H222K	CHIP C 2200PF K	M
C357A,B			C90-2597-05	ELECTRO 10UF 16WV	M
C358A,B			C90-2597-05	ELECTRO 10UF 16WV	M
C359A,B			C90-2597-05	ELECTRO 10UF 16WV	M
C400			CK73FB1C104K	CHIP C 0.10UF K	
C401			CK73FB1C104K	CHIP C 0.10UF K	
C450			CK73FB1C104K	CHIP C 0.10UF K	
C451A,B			C90-2606-05	ELECTRO 0.47UF 50WV	
C452			CE04CW1C470M	ELECTRO 47UF 16WV	
C501			CK73EB1H224K	CHIP C 0.22UF K	
C502			CK73EB1H224K	CHIP C 0.22UF K	
C503			C90-2877-08	ELECTRO 1.0UF 50WV	
C504			CE04CW1C220M	ELECTRO 22UF 16WV	
C505			C90-2613-05	ELECTRO 0.47UF 50WV	
C506A,B			CK73FB1C474K	CHIP C 0.47UF K	
C507A,B			CK73FB1C474K	CHIP C 0.47UF K	
C508A,B			CK73FB1C474K	CHIP C 0.47UF K	
C509A,B			CK73FB1C474K	CHIP C 0.47UF K	
C510A,B			CK73EB1E104K	CHIP C 0.10UF K	
C511A,B			CK73EB1E104K	CHIP C 0.10UF K	
C512A,B			CK73EB1E104K	CHIP C 0.10UF K	
C513A,B			CK73EB1E104K	CHIP C 0.10UF K	
C600			C90-2822-05	ELECTRO 3900UF 16WV	
C603			CK73GB1H102K	CHIP C 1000PF K	
C604			CK73GB1H103K	CHIP C 0.010UF K	
C605			CK73GB1H103K	CHIP C 0.010UF K	
C606			CE04CW1H0R1M	ELECTRO 0.1UF 50WV	
C607			CK73GB1H683K	CHIP C 0.068UF K	
C608			CE04CW1H3R3M	ELECTRO 3.3UF 50WV	
C609			CK73GB0J105K	CHIP C 1.0UF K	
C610			C93-1151-08	CHIP C 0.022UF K	
C613			CE04CW1E101M	ELECTRO 100UF 25WV	
C614			CE04CW1E101M	ELECTRO 100UF 25WV	
C615			C90-2597-05	ELECTRO 10UF 16WV	
C616			CK73GB1H103K	CHIP C 0.010UF K	
C617			CE04CW1A101M	ELECTRO 100UF 10WV	
C618			CK73GB1H103K	CHIP C 0.010UF K	
C619			CE04CW1A101M	ELECTRO 100UF 10WV	
C620			CK73GB1H104K	CHIP C 0.10UF K	
C621		*	C92-1682-08	ELECTRO 100UF 16WV	
C622			CK73GB1H103K	CHIP C 0.010UF K	
C623			CE04CW1A101M	ELECTRO 100UF 10WV	
C624			CE04CW1E101M	ELECTRO 100UF 25WV	

KDC-Z727,Z727

PARTS LIST

* New Parts

Parts without **Parts No.** are not supplied.

Les articles non mentionnes dans le **Parts No.** ne sont pas fournis.

Teile ohne **Parts No.** werden nicht geliefert.

MAIN UNIT

Ref. No.	A d d	N e w	Parts No.	Description	Dest inati on
C625			CK73GB1H103K	CHIP C 0.010UF K	
C626			CE04CW1A101M	ELECTRO 100UF 10WV	
C630			CE04CW1E101M	ELECTRO 100UF 25WV	
C631			CE04CW1E101M	ELECTRO 100UF 25WV	
C632			CE04CW1V4R7M	ELECTRO 4.7UF 35WV	M
C801		*	C92-1683-08	ELECTRO 100UF 16WV	M
C802			CK73EB1C225K	CHIP C 2.2UF K	M
C803			CK73EB1C225K	CHIP C 2.2UF K	M
C804			CK73EB1C225K	CHIP C 2.2UF K	M
C805			CK73EB1C225K	CHIP C 2.2UF K	M
C806			CE04CW1C220M	ELECTRO 22UF 16WV	M
C807			CK73GB1H103K	CHIP C 0.010UF K	M
C808			CK73EB1C225K	CHIP C 2.2UF K	M
C809			CE04CW1V4R7M	ELECTRO 4.7UF 35WV	M
C810			C93-1151-08	CHIP C 0.022UF K	M
C812			CK73EB1C225K	CHIP C 2.2UF K	M
273	2D		E30-4857-08	CORD WITH PLUG (ANT)	
274	2D	*	E30-6017-08	CORD WITH PLUG (PRE OUT)	K
274	2D	*	E30-6019-08	CORD WITH PLUG (PRE OUT)	M
275	2D	*	E30-6018-08	CORD WITH PLUG (AUX IN)	K
275	2D	*	E30-6020-08	CORD WITH PLUG (RCA)	M
CN1			E40-9490-05	PIN ASSY (20P)	
CN100			E40-9757-08	PIN ASSY (3P)	
CN200			E40-9550-05	FLAT CABLE CONNECTOR (22P)	
CN350		*	E41-0163-08	PIN ASS'Y	K
CN350		*	E41-0165-08	PIN ASSY (6P)	M
CN400			E56-0834-05	CYLINDRICAL RECEPTACLE(13P DIN)	
CN450		*	E41-0162-08	PIN ASS'Y	K
CN450		*	E41-0164-08	PIN ASSY (6P)	M
CN600			E58-0836-05	RECTANGULAR RECEPTACLE (16P)	
279	2D	*	F12-0752-08	SHIELDING TUBE	
F1	2D		F06-1032-05	FUSE 10A	
L1			L33-1127-08	CHOKE COIL 4.7uH	
L100			L33-1123-05	AM ANT COIL	
L102-106			L33-1127-08	CHOKE COIL 4.7uH	
L300			L33-1127-08	CHOKE COIL 4.7uH	
L801			L40-4705-34	SMALL FIXED INDUCTOR	M
X1		*	L77-2790-08	CRYSTAL RESONATOR 20MHz	
X2			L78-0533-05	RESONATOR 32.768KHz	
K	1D		N30-3004-46	PAN HEAD MACHINE SCREW	
P	2D		N35-3006-46	BINDING HEAD MACHINE SCREW	
Q	3D		N30-2005-45	PAN HEAD MACHINE SCREW	
R	2D		N89-3006-46	BINDING HEAD TAPTITE SCREW	
S	1D	*	N09-4497-08	MACHINE SCREW	
JP1			R92-2053-05	CHIP R 0 J 1/8W	
JP2			R92-1252-05	CHIP R 0 OHM	
R1			RK73GB1J473J	CHIP R 47K J 1/16W	
R2			R92-1252-05	CHIP R 0 OHM	
R3			RK73GB1J104J	CHIP R 100K J 1/16W	
R4			RK73GB1J222J	CHIP R 2.2K J 1/16W	
R5			RK73GB1J223J	CHIP R 22K J 1/16W	
R6			RK73GB1J102J	CHIP R 1.0K J 1/16W	
R7			RK73GB1J684J	CHIP R 680K J 1/16W	

Ref. No.	A d d	N e w	Parts No.	Description	Dest inati on
R8			RK73GB1J102J	CHIP R 1.0K J 1/16W	
R9			RK73GB1J473J	CHIP R 47K J 1/16W	
R10			RK73GB1J473J	CHIP R 47K J 1/16W	
R11			RK73GB1J471J	CHIP R 470 J 1/16W	
R12			RK73GB1J102J	CHIP R 1.0K J 1/16W	
R14			RK73GB1J471J	CHIP R 470 J 1/16W	
R15			R92-1252-05	CHIP R 0 OHM	
R16			RK73GB1J105J	CHIP R 1.0M J 1/16W	
R17			RK73GB1J222J	CHIP R 2.2K J 1/16W	
R18			RK73GB1J473J	CHIP R 47K J 1/16W	
R20			RK73GB1J473J	CHIP R 47K J 1/16W	
R22			RK73GB1J473J	CHIP R 47K J 1/16W	
R24			RK73GB1J102J	CHIP R 1.0K J 1/16W	
R25			RK73GB1J102J	CHIP R 1.0K J 1/16W	
R26 -28			RK73GB1J104J	CHIP R 100K J 1/16W	
R29			RK73GB1J223J	CHIP R 22K J 1/16W	
R30			RK73GB1J472J	CHIP R 4.7K J 1/16W	
R31			RK73FB2A392J	CHIP R 3.9K J 1/10W	
R32			RK73FB2A471J	CHIP R 470 J 1/10W	
R33			RK73FB2A471J	CHIP R 470 J 1/10W	
R34			RK73FB2A102J	CHIP R 1.0K J 1/10W	
R35			RK73FB2A471J	CHIP R 470 J 1/10W	
R36			RK73FB2A102J	CHIP R 1.0K J 1/10W	
R37			RK73FB2A102J	CHIP R 1.0K J 1/10W	
R38			RK73GB1J471J	CHIP R 470 J 1/16W	
R39			RK73GB1J473J	CHIP R 47K J 1/16W	
R40			RK73GB1J471J	CHIP R 470 J 1/16W	
R41			RK73GB1J473J	CHIP R 47K J 1/16W	
R43 -45			RK73GB1J473J	CHIP R 47K J 1/16W	M
R46			RK73GB1J331J	CHIP R 330 J 1/16W	
R47 -49			RK73GB1J102J	CHIP R 1.0K J 1/16W	
R50			RK73GB1J473J	CHIP R 47K J 1/16W	
R51			RK73GB1J473J	CHIP R 47K J 1/16W	
R100			RK73GB1J223J	CHIP R 22K J 1/16W	
R101			RK73GB1J222J	CHIP R 2.2K J 1/16W	
R102			RK73GB1J223J	CHIP R 22K J 1/16W	
R103			RK73GB1J222J	CHIP R 2.2K J 1/16W	
R104			RK73FB2A151J	CHIP R 150 J 1/10W	
R106			R92-2053-05	CHIP R 0 J 1/8W	
R200			RK73GB1J104J	CHIP R 100K J 1/16W	
R201			RK73GB1J222J	CHIP R 2.2K J 1/16W	
R205			RK73GB1J104J	CHIP R 100K J 1/16W	
R206			RK73GB1J104J	CHIP R 100K J 1/16W	
R208			RK73GB1J473J	CHIP R 47K J 1/16W	
R209A,B			RK73GB1J473J	CHIP R 47K J 1/16W	
R212			RK73GB1J100J	CHIP R 10 J 1/16W	
R215A,B			RK73GB1J394J	CHIP R 390K J 1/16W	
R216			RK73GB1J103J	CHIP R 10K J 1/16W	
R217			RK73GB1J471J	CHIP R 470 J 1/16W	
R218			RK73GB1J473J	CHIP R 47K J 1/16W	
R219			RK73GB1J102J	CHIP R 1.0K J 1/16W	
R220			RK73GB1J333J	CHIP R 33K J 1/16W	
R221			RK73GB1J242J	CHIP R 2.4K J 1/16W	
R222			RK73GB1J104J	CHIP R 100K J 1/16W	
R223			RK73GB1J392J	CHIP R 3.9K J 1/16W	

E: Europe K: North America M: Other Areas
W: Without Europe

K: Z727
M: KDC-Z727

△ indicates safety critical components.

KDC-Z727,Z727

PARTS LIST

* New Parts

Parts without **Parts No.** are not supplied.

Les articles non mentionnes dans le **Parts No.** ne sont pas fournis.

Teile ohne **Parts No.** werden nicht geliefert.

MAIN UNIT

Ref. No.	A d d	N e w	Parts No.	Description	Dest inati on	Ref. No.	A d d	N e w	Parts No.	Description	Dest inati on
R224			RK73GB1J822J	CHIP R 8.2K J 1/16W		R610			R90-1044-08	FL-PROOF RS 1.2K J 1/2W	
R225			RK73GB1J103J	CHIP R 10K J 1/16W		R611			R90-1044-08	FL-PROOF RS 1.2K J 1/2W	
R300			RK73GB1J103J	CHIP R 10K J 1/16W		R612			RK73GB1J472J	CHIP R 4.7K J 1/16W	
R301			RK73GB1J472J	CHIP R 4.7K J 1/16W		R613			RD14DB2H102J	SMALL-RD 1.0K J 1/2W	
R302			RK73GB1J472J	CHIP R 4.7K J 1/16W		R614			RK73GB1J223J	CHIP R 22K J 1/16W	
R303			RK73GB1J102J	CHIP R 1.0K J 1/16W		R615			RD14DB2H102J	SMALL-RD 1.0K J 1/2W	
R310A,B			R92-1252-05	CHIP R 0 OHM		R616			RK73GB1J104J	CHIP R 100K J 1/16W	
R350A,B			RK73GB1J471J	CHIP R 470 J 1/16W		R617			RK73EB2B103J	CHIP R 10K J 1/8W	
R351A,B			RK73GB1J471J	CHIP R 470 J 1/16W		R618			RK73EB2B102J	CHIP R 1.0K J 1/8W	
R352A,B			RK73GB1J222J	CHIP R 2.2K J 1/16W	M	R619			RK73GB1J561J	CHIP R 560 J 1/16W	
R352A,B			RK73GB1J223J	CHIP R 22K J 1/16W	K	R622			RK73GB1J223J	CHIP R 22K J 1/16W	
R353A,B			RK73GB1J222J	CHIP R 2.2K J 1/16W	M	R623			RK73EB2B1R0J	CHIP R 1.0 J 1/8W	
R353A,B			RK73GB1J223J	CHIP R 22K J 1/16W	K	R624			RK73EB2B1R0J	CHIP R 1.0 J 1/8W	
R354A,B			RK73FB2A820J	CHIP R 82 J 1/10W		R625			RK73GB1J152J	CHIP R 1.5K J 1/16W	
R355A,B			RK73FB2A820J	CHIP R 82 J 1/10W		R626			RK73GB1J103J	CHIP R 10K J 1/16W	
R358A,B			RK73GB1J471J	CHIP R 470 J 1/16W	M	R627			RK73GB1J102J	CHIP R 1.0K J 1/16W	
R359A,B			RK73GB1J222J	CHIP R 2.2K J 1/16W	M	R628			RK73GB1J102J	CHIP R 1.0K J 1/16W	
R360A,B			RK73FB2A820J	CHIP R 82 J 1/10W	M	R629			RK73GB1J152J	CHIP R 1.5K J 1/16W	
R361A,B			RK73GB1J103J	CHIP R 10K J 1/16W	M	R630			RK73GB1J104J	CHIP R 100K J 1/16W	M
R363A,B			RK73GB1J103J	CHIP R 10K J 1/16W	M	R631			RK73GB1J102J	CHIP R 1.0K J 1/16W	M
R364A,B			RK73GB1J103J	CHIP R 10K J 1/16W	M	R632			RK73FB2A750J	CHIP R 75 J 1/10W	M
R365A,B			R92-1252-05	CHIP R 0 OHM	K	R639			RK73GB1J104J	CHIP R 100K J 1/16W	
R366A,B			R92-1252-05	CHIP R 0 OHM	K	R801			RK73GB1J272J	CHIP R 2.7K J 1/16W	M
R368A,B			RK73GB1J223J	CHIP R 22K J 1/16W	M	R802			RK73GB1J470J	CHIP R 47 J 1/16W	M
R369A,B			RK73GB1J223J	CHIP R 22K J 1/16W	M	R803			RK73GB1J752J	CHIP R 7.5K J 1/16W	M
R370A,B			RK73GB1J223J	CHIP R 22K J 1/16W	M	R804			RK73GB1J563J	CHIP R 56K J 1/16W	M
R400			RK73FB2A470J	CHIP R 47 J 1/10W		R805			RK73GB1J913J	CHIP R 91K J 1/16W	M
R401A,B			RK73FB2A101J	CHIP R 100 J 1/10W		R806			RK73GB1J470J	CHIP R 47 J 1/16W	M
R402			RK73FB2A470J	CHIP R 47 J 1/10W		R807			RK73GB1J103J	CHIP R 10K J 1/16W	M
R403			RK73FB2A102J	CHIP R 1.0K J 1/10W		R808			RK73GB1J913J	CHIP R 91K J 1/16W	M
R404			RK73FB2A102J	CHIP R 1.0K J 1/10W		R809			RK73GB1J913J	CHIP R 91K J 1/16W	M
R405			RK73FB2A222J	CHIP R 2.2K J 1/10W		RN1			R90-0724-05	MULTI-COMP 1K X4	
R406			RK73FB2A472J	CHIP R 4.7K J 1/10W		RN2			R90-0724-05	MULTI-COMP 1K X4	
R407			RK73FB2A472J	CHIP R 4.7K J 1/10W		RN3			R90-1071-08	MULTI-COMP 47 X2	
R408			RK73FB2A470J	CHIP R 47 J 1/10W		RN4		*	R90-0724-05	MULTI-COMP 1K X4	
R450A,B			RK73FB2A101J	CHIP R 100 J 1/10W		RN5			R90-1016-05	MULTI-COMP 470 X4	
R500			RK73GB1J473J	CHIP R 47K J 1/16W		RN6			R90-1016-05	MULTI-COMP 470 X4	
R501			RK73GB1J242J	CHIP R 2.4K J 1/16W		RN7			R90-1042-08	MULTI-COMP 4.7K X4	
R502			R92-1252-05	CHIP R 0 OHM		RN8			R90-0724-05	MULTI-COMP 1K X4	
R503			RK73GB1J103J	CHIP R 10K J 1/16W		RN10			R90-0724-05	MULTI-COMP 1K X4	
R504			RK73GB1J101J	CHIP R 100 J 1/16W		RN11			R90-0724-05	MULTI-COMP 1K X4	
R505			RK73GB1J682J	CHIP R 6.8K J 1/16W		RN12			R90-0720-05	MULTI-COMP 100K X4	
R507			RK73GB1J103J	CHIP R 10K J 1/16W		RN14			R90-0724-05	MULTI-COMP 1K X4	
R508A,B			RK73GB1J103J	CHIP R 10K J 1/16W		RN15			R90-1071-08	MULTI-COMP 47 X2	
R509A,B			RK73GB1J103J	CHIP R 10K J 1/16W		RN16			R90-1022-05	MULTI-COMP 470 X2	
R600			RK73GB1J104J	CHIP R 100K J 1/16W		RN17			R90-0724-05	MULTI-COMP 1K X4	
R601			RK73GB1J243J	CHIP R 24K J 1/16W		RN400			R90-0720-05	MULTI-COMP 100K X4	
R602			RK73GB1J103J	CHIP R 10K J 1/16W		S1			S74-0809-05	MICRO SWITCH	
R603			RK73GB1J103J	CHIP R 10K J 1/16W		D1 -4		*	HZM6.2ZWA	ZENER DIODE	
R604			RK73GB1J104J	CHIP R 100K J 1/16W		D7			1SS400	DIODE	
R605			RD14DB2H332J	SMALL-RD 3.3K J 1/2W		D8			1SS400	DIODE	
R606			RK73EB2B333J	CHIP R 33K J 1/8W		D100			MA4051(N)-M	ZENER DIODE	
R607			RK73GB1J103J	CHIP R 10K J 1/16W		D200-203			1SS400	DIODE	
R608			RK73GB1J472J	CHIP R 4.7K J 1/16W							
R609			RK73GB1J223J	CHIP R 22K J 1/16W							

E: Europe K: North America M: Other Areas
W: Without Europe

K: Z727
M: KDC-Z727

△ indicates safety critical components.

KDC-Z727,Z727

PARTS LIST

* New Parts

Parts without **Parts No.** are not supplied.

Les articles non mentionnes dans le **Parts No.** ne sont pas fournis.

Teile ohne **Parts No.** werden nicht geliefert.

MAIN UNIT

Ref. No.	A d d	N e w	Parts No.	Description	Dest inati on
D204 D350A,B D351A,B D352A,B D400-403			STZ6.8N STZ6.2Z STZ6.2Z STZ6.2Z STZ6.2Z	ZENER DIODE ZENER DIODE ZENER DIODE ZENER DIODE ZENER DIODE	M
D404A,B D405 D450A,B D451 D500			STZ6.2Z STZ6.2Z STZ6.2Z STZ6.2Z DAP202U	ZENER DIODE ZENER DIODE ZENER DIODE ZENER DIODE DIODE	
D501 D502A,B D503A,B D504A,B D505A,B			1SS400 1SR154-400 1SR154-400 1SR154-400 1SR154-400	DIODE DIODE DIODE DIODE DIODE	
D600 D601 D602 D603 D604			RM10Z HZS7L6C HZS7L6C 1SR154-400 1SR154-400	DIODE ZENER DIODE ZENER DIODE DIODE DIODE	
D605 D606 D607 D608 D610		*	1SS400 1SR154-400 1SR154-400 UDZS5.6B 1SR154-400	DIODE DIODE DIODE ZENER DIODE DIODE	
D611 D612 D613 D614 D621			HZS6B1L MA8180-L MA4082(N)-L DTZ9.1A HZS11B2L	ZENER DIODE ZENER DIODE ZENER DIODE ZENER DIODE ZENER DIODE	M
D801 IC1 IC2 IC3 IC200		*	HZS6B1L UPD703033GC060 S-80842ANNP HD74HC27FP BA3121F	ZENER DIODE MI-COM IC MOS-IC MOS-IC IC(ISO AMP)	M
IC201 IC202 IC300 IC301 IC310-312			BA3129F NJM4565MD TDA7407 TDA7401 NJM4565MD	IC(SWITCH) IC(OP AMP X2) ANALOGUE IC ANALOGUE IC IC(OP AMP X2)	M
IC500 IC891 Q1 Q2 Q3			TA8263BH TC7662BEOA 2SA1576A DTA124EUA DTA144EUA	ANALOGUE IC ANALOGUE IC TRANSISTOR DIGITAL TRANSISTOR DIGITAL TRANSISTOR	M
Q4 Q5 Q6 Q9 Q10			DTC124EUA 2SB1427 DTC144EUA DTC144EUA DTC124EUA	DIGITAL TRANSISTOR TRANSISTOR DIGITAL TRANSISTOR DIGITAL TRANSISTOR DIGITAL TRANSISTOR	
Q100 Q101 Q102 Q103 Q200			2SB1132 DTC144EUA 2SB1132 DTC144EUA DTC124EUA	TRANSISTOR DIGITAL TRANSISTOR TRANSISTOR DIGITAL TRANSISTOR DIGITAL TRANSISTOR	

Ref. No.	A d d	N e w	Parts No.	Description	Dest inati on
Q201 Q202 Q300 Q350A,B Q351A,B			DTC343TK 2SC4081 DTC144EUA DTC343TK DTC343TK	DIGITAL TRANSISTOR TRANSISTOR DIGITAL TRANSISTOR DIGITAL TRANSISTOR DIGITAL TRANSISTOR	
Q352A,B Q600 Q601 Q602 Q603			DTC343TK 2SC4081 2SC4081 DTC114YUA 2SA1703-AN	DIGITAL TRANSISTOR TRANSISTOR TRANSISTOR DIGITAL TRANSISTOR TRANSISTOR	M
Q604 Q605 Q606 Q607 Q608			DTC114EUA DTA124EUA 2SA1576A 2SA1703-AN DTC144EUA	DIGITAL TRANSISTOR DIGITAL TRANSISTOR TRANSISTOR TRANSISTOR DIGITAL TRANSISTOR	
Q609 Q611 Q612 Q613 Q614			DTA123JUA 2SC4081 2SB1565(E,F) 2SC4081 2SB1565(E,F)	DIGITAL TRANSISTOR TRANSISTOR TRANSISTOR TRANSISTOR TRANSISTOR	
Q615 Q616 Q617 Q618 Q619			DTC124EUA DTA124EUA 2SC4081 2SB1184 2SC4081	DIGITAL TRANSISTOR DIGITAL TRANSISTOR TRANSISTOR TRANSISTOR TRANSISTOR	
Q620 Q621 Q622 Q623 Q624			2SB1565(E,F) 2SC4081 2SB1565(E,F) DTC144EUA DTA124EUA	TRANSISTOR TRANSISTOR TRANSISTOR DIGITAL TRANSISTOR DIGITAL TRANSISTOR	
Q632 Q633 Q801 Q802 Q803-805			2SC4081 2SB1443 2SA1576A 2SA1576A 2SC4081	TRANSISTOR TRANSISTOR TRANSISTOR TRANSISTOR TRANSISTOR	M M M M M
Q806 TH500			2SA1576A TH470	TRANSISTOR POSITIVE RESISTOR	M
TU100			X86-3240-11	TUNER UNIT	
DC/DC CONVERTER UNIT					
C700 C701 C702 C703 C704			CK73GB1H104K C90-2603-05 CK73GB1H104K C90-2603-05 * C93-1191-08	CHIP C 0.10UF K ELECTRO 0.15UF 50WV CHIP C 0.10UF K ELECTRO 0.15UF 50WV CHIP C 0.001UF K	
C705-707 C708		*	* C90-5397-08 * C90-5398-08	ELECTRO 47UF 63WV ELECTRO 22UF 63WV	
CN700 CN701 CN702 CN703		*	* E41-0161-08 * E41-0161-08 E40-9602-08 E40-9602-08	PIN ASSY (4P) PIN ASSY (4P) PIN ASSY (4P) PIN ASSY (4P)	
L700			L33-1090-08	CHOKE COIL 56 uH	
R700			RK73EB2B102J	CHIP R 1.0K J 1/8W	

E: Europe K: North America M: Other Areas
W: Without Europe

K: Z727
M: KDC-Z727

△ indicates safety critical components.

KDC-Z727,Z727

PARTS LIST

* New Parts

Parts without **Parts No.** are not supplied.

Les articles non mentionnes dans le **Parts No.** ne sont pas fournis.

Teile ohne **Parts No.** werden nicht geliefert.

DC/DC CONVERTER UNIT

Ref. No.	Added	New	Parts No.	Description	Destination
R702			RK73EB2B220J	CHIP R 22 J 1/8W	
R703			RK73FB2A473J	CHIP R 47K J 1/10W	
D700			PTZ5.6A	DIODE	
DC700		*	W02-3302-08	DC/DC CONVERTER	
SUB UNIT					
D800			B30-2025-05	LED (CL-170PG)	
CN800			E40-9488-05	SOCKET FOR PIN ASSY (20P)	
CN801			E40-9414-05	FLAT CABLE CONNECTOR (15P)	
R800			RK73GB1J820J	CHIP R 82 J 1/16W	
S800		*	S70-0886-08	TACT SWITCH	
CONTROL UNIT					
D900			B30-1564-05	LED (CL-190UB)	
D901		*	B30-1628-08	LED (LBA673)	
D982			B30-1547-05	LED (CL-190PG)	
D983			B30-1547-05	LED (CL-190PG)	
D985			B30-1547-05	LED (CL-190PG)	
D986			B30-1547-05	LED (CL-190PG)	
D989			B30-1547-05	LED (CL-190PG)	
D990			B30-1547-05	LED (CL-190PG)	
D994			B30-1547-05	LED (CL-190PG)	
D997			B30-1547-05	LED (CL-190PG)	
C900			CK73GB1H103K	CHIP C 0.010UF K	
C901			C90-5327-08	CHIP-TAN 10UF 16WV	
C902			CK73GB1H103K	CHIP C 0.010UF K	
C903			CK73GB1H103K	CHIP C 0.010UF K	
C904			CK73GB0J105K	CHIP C 1.0UF K	
C905			CC73GCH1H120J	CHIP C 12PF J	
C906			CC73GCH1H120J	CHIP C 12PF J	
C907-911			CK73GB1H103K	CHIP C 0.010UF K	
C930			C90-5327-08	CHIP-TAN 10UF 16WV	
C940			C90-5327-08	CHIP-TAN 10UF 16WV	
C941			C90-5327-08	CHIP-TAN 10UF 16WV	
C943			C90-5327-08	CHIP-TAN 10UF 16WV	
C950			CK73GB1H104K	CHIP C 0.10UF K	
C951			C90-5327-08	CHIP-TAN 10UF 16WV	
C960			CK73GB1H103K	CHIP C 0.010UF K	
C961			CK73FF1A475Z	CHIP C 4.7UF Z	
C962		*	C93-1191-08	CHIP C 0.001UF K	
C963			CK73FF1A475Z	CHIP C 4.7UF Z	
C964			CK73GB1H103K	CHIP C 0.010UF K	
C965			CK73GB0J105K	CHIP C 1.0UF K	
C966			CK73GB1H104K	CHIP C 0.10UF K	
CN900			E59-0835-05	RECTANGULAR PLUG (13PTDF)	
282	3C	*	J19-5115-08	HOLDER (VFD)	
L900			L33-1127-08	CHOKE COIL 4.7uH	
L901		*	L92-0348-08	CHIP IMPEDER 1K	
L950			L33-1127-08	CHOKE COIL 4.7uH	
L960		*	L92-0348-08	CHIP IMPEDER 1K	
L961			L33-1127-08	CHOKE COIL 4.7uH	

Ref. No.	Added	New	Parts No.	Description	Destination
X1		*	L77-2790-08	CRYSTAL RESONATOR 20MHz	
R900			RK73GB1J102J	CHIP R 1.0K J 1/16W	
R901			R92-1252-05	CHIP R 0 OHM	
R902			RK73GB1J471J	CHIP R 470 J 1/16W	
R903			RK73GB1J104J	CHIP R 100K J 1/16W	
R904			RK73GB1J102J	CHIP R 1.0K J 1/16W	
R905			RK73GB1J104J	CHIP R 100K J 1/16W	
R906			RK73GB1J102J	CHIP R 1.0K J 1/16W	
R907			RK73GB1J471J	CHIP R 470 J 1/16W	
R908			RK73GB1J471J	CHIP R 470 J 1/16W	
R909			RK73GB1J223J	CHIP R 22K J 1/16W	
R910			RK73GB1J101J	CHIP R 100 J 1/16W	
R911			RK73GB1J131J	CHIP R 130 J 1/16W	
R912			RK73GB1J103J	CHIP R 10K J 1/16W	
R913			RK73FB2A392J	CHIP R 3.9K J 1/10W	
R914-918			RK73FB2A471J	CHIP R 470 J 1/10W	
R919			RK73GB1J223J	CHIP R 22K J 1/16W	
R920			RK73GB1J103J	CHIP R 10K J 1/16W	
R921			RK73GB1J472J	CHIP R 4.7K J 1/16W	
R930			RK73GB1J101J	CHIP R 100 J 1/16W	
R940			RK73GB1J392J	CHIP R 3.9K J 1/16W	
R941			RK73GB1J473J	CHIP R 47K J 1/16W	
R942			RK73GB1J124J	CHIP R 120K J 1/16W	
R943			RK73GB1J274J	CHIP R 270K J 1/16W	
R944			RK73GB1J274J	CHIP R 270K J 1/16W	
R945			RK73GB1J100J	CHIP R 10 J 1/16W	
R960			RK73EB2B100J	CHIP R 10 J 1/8W	
R961			RK73GB1J100J	CHIP R 10 J 1/16W	
R962			RK73GB1J222J	CHIP R 2.2K J 1/16W	
R963			RK73GB1J101J	CHIP R 100 J 1/16W	
R964			RK73GB1J101J	CHIP R 100 J 1/16W	
R965			RK73GB1J473J	CHIP R 47K J 1/16W	
R966			RK73GB1J101J	CHIP R 100 J 1/16W	
R967			RK73GB1J101J	CHIP R 100 J 1/16W	
R980-982			RK73EB2B392J	CHIP R 3.9K J 1/8W	
RN900			R90-0737-05	MULTI-COMP 100K X2	
RN901			R90-1014-05	MULTI-COMP 100 X4	
RN902			R90-1019-05	MULTI-COMP 100 X2	
RN903			R90-1019-05	MULTI-COMP 100 X2	
RN904			R90-0720-05	MULTI-COMP 100K X4	
RN905			R90-0724-05	MULTI-COMP 1K X4	
RN906			R90-0725-05	MULTI-COMP 1K X2	
RN907			R90-1020-05	MULTI-COMP 22K X2	
RN908			R90-1022-05	MULTI-COMP 470 X2	
RN950			R90-1014-05	MULTI-COMP 100 X4	
RN951			R90-0748-05	MULTI-COMP 47K X4	
RN952			R90-1014-05	MULTI-COMP 100 X4	
RN953			R90-0748-05	MULTI-COMP 47K X4	
RN954			R90-1014-05	MULTI-COMP 100 X4	
RN955			R90-0748-05	MULTI-COMP 47K X4	
RN956			R90-1014-05	MULTI-COMP 100 X4	
RN957			R90-0748-05	MULTI-COMP 47K X4	
S900		*	S70-0887-08	TACT SWITCH	

E: Europe K: North America M: Other Areas
W: Without Europe

K: Z727
M: KDC-Z727

△ indicates safety critical components.

PARTS LIST

* New Parts

Parts without **Parts No.** are not supplied.

Les articles non mentionnes dans le **Parts No.** ne sont pas fournis.

Teile ohne **Parts No.** werden nicht geliefert.

CONTROL UNIT

Ref. No.	Add	New	Parts No.	Description	Destination
S901			S70-0864-05	TACT SWITCH	
S980		*	S70-0886-08	TACT SWITCH	
S981		*	S70-0886-08	TACT SWITCH	
S982		*	S70-0887-08	TACT SWITCH	
S983		*	S70-0887-08	TACT SWITCH	
S984		*	S70-0886-08	TACT SWITCH	
S985		*	S70-0887-08	TACT SWITCH	
S986		*	S70-0887-08	TACT SWITCH	
S987		*	S70-0886-08	TACT SWITCH	
S988		*	S70-0886-08	TACT SWITCH	
S989		*	S70-0887-08	TACT SWITCH	
S990		*	S70-0887-08	TACT SWITCH	
S991-993		*	S70-0886-08	TACT SWITCH	
S994		*	S70-0887-08	TACT SWITCH	
S995		*	S70-0886-08	TACT SWITCH	
S996		*	S70-0886-08	TACT SWITCH	
S997		*	S70-0887-08	TACT SWITCH	
D903			DA227	DIODE	
D904			DA227	DIODE	
D905-908		*	HZM6.2ZWA	ZENER DIODE	
D960		*	HZM6.2ZWA	ZENER DIODE	
D961		*	HZM6.2ZWA	ZENER DIODE	
IC900		*	UPD703033GC062	MI-COM IC	
IC930			RS-171	ANALOGUE IC	
IC940			BA3830F	ANALOGUE IC	
IC950		*	MSM531622F95TS	MEMORY IC	
IC960			BA033LBSG	ANALOGUE IC	
IC961			TC74HC4050AFT	MOS-IC	
Q900			2SC4081	TRANSISTOR	
Q930			DTA114EUA	DIGITAL TRANSISTOR	
Q931			DTC124EUA	DIGITAL TRANSISTOR	
Q960			DTC114EUA	DIGITAL TRANSISTOR	
Q961			DTA124EUA	DIGITAL TRANSISTOR	
Q962			DTC114EUA	DIGITAL TRANSISTOR	
VFD960		*	CN1989M	FLUORESCENT INDICATOR TUBE	
CD PLAYER UNIT (X32-5030-01)					
C1 ,2			CK73FB1C105K	CHIP C 1.0UF	K
C3			CK73FB0J475K	CHIP C 4.7UF	K
C4			C92-0566-05	CHIP-TAN 10UF	6.3WV
C5			CC73GCH1H150J	CHIP C 15PF	J
C6			CC73GCH1H020C	CHIP C 2.0PF	C
C7			CK73GB1C104K	CHIP C 0.10UF	K
C8			CK73FB1C105K	CHIP C 1.0UF	K
C10			CK73GB1H472K	CHIP C 4700PF	K
C11			CK73GB1H682K	CHIP C 6800PF	K
C12			CK73GB1H332K	CHIP C 3300PF	K
C13			CK73GB1C333K	CHIP C 0.033UF	K
C14			CK73GB1H472K	CHIP C 4700PF	K
C15			CK73GB1C473K	CHIP C 0.047UF	K
C16			CC73GCH1H151J	CHIP C 150PF	J
C17			CK73GB1H472K	CHIP C 4700PF	K
C18			CC73GCH1H221J	CHIP C 220PF	J
C19 ,20			CK73GB1C104K	CHIP C 0.10UF	K
C21			CK73FB0J475K	CHIP C 4.7UF	K

Ref. No.	Add	New	Parts No.	Description	Destination
C23			CK73GB1H102K	CHIP C 1000PF	K
C24			CK73GB1E223K	CHIP C 0.022UF	K
C25			CK73GB1H153K	CHIP C 0.015UF	K
C26			CK73GB0J105K	CHIP C 1.0UF	K
C28			CK73GB0J105K	CHIP C 1.0UF	K
C29			CK73GB1C104K	CHIP C 0.10UF	K
C33 -35			CK73GB1C104K	CHIP C 0.10UF	K
C41			CK73EB1C225K	CHIP C 2.2UF	K
C43			CK73GB1H153K	CHIP C 0.015UF	K
C45			CK73GB1H153K	CHIP C 0.015UF	K
C46			CK73GB1C473K	CHIP C 0.047UF	K
C51			CK73FB1C105K	CHIP C 1.0UF	K
C55			CK73GB1C104K	CHIP C 0.10UF	K
C63			C92-1359-05	CHIP-TAN 10UF	16WV
C67 ,68			CK73GB0J105K	CHIP C 1.0UF	K
C71 ,72			CK73GB1H471K	CHIP C 470PF	K
C77 ,78			CC73GCH1H680J	CHIP C 68PF	J
C79 ,80			CK73GB1H222K	CHIP C 2200PF	K
C85			CK73GB1C104K	CHIP C 0.10UF	K
C89			CK73GB1H222K	CHIP C 2200PF	K
CN1			E40-9536-05	FLAT CABLE CONNECTOR	
CN2			E40-9339-05	FLAT CABLE CONNECTOR	
CN2			E41-0036-05	FLAT CABLE CONNECTOR	
CN2			E41-0129-05	FLAT CABLE CONNECTOR	
X1			L78-0572-05	RESONATOR (16.93MHZ)	
CP1 -3			R90-1019-05	MULTI-COMP 100	X2
R3			RK73GB1J272J	CHIP R 2.7K	J 1/16W
R5			RK73GB1J361J	CHIP R 360	J 1/16W
R6			RK73GB1J272J	CHIP R 2.7K	J 1/16W
R8			RK73EB2B4R7J	CHIP R 4.7	J 1/8W
R9			RK73EB2B100J	CHIP R 10	J 1/8W
R10 ,11			RK73GB1J103J	CHIP R 10K	J 1/16W
R12			RK73GB1J912J	CHIP R 9.1K	J 1/16W
R15			RK73GB1J824J	CHIP R 820K	J 1/16W
R16			RK73GB1J223J	CHIP R 22K	J 1/16W
R17			RK73GB1J433J	CHIP R 43K	J 1/16W
R18			RK73GB1J392J	CHIP R 3.9K	J 1/16W
R19			RK73GB1J513J	CHIP R 51K	J 1/16W
R20			RK73GB1J104J	CHIP R 100K	J 1/16W
R21			RK73GB1J244J	CHIP R 240K	J 1/16W
R32			RK73GB1J104J	CHIP R 100K	J 1/16W
R34			RK73GB1J683J	CHIP R 68K	J 1/16W
R36			RK73GB1J151J	CHIP R 150	J 1/16W
R37			RK73GB1J471J	CHIP R 470	J 1/16W
R38			RK73GB1J224J	CHIP R 220K	J 1/16W
R44			RK73GB1J512J	CHIP R 5.1K	J 1/16W
R45			RK73GB1J103J	CHIP R 10K	J 1/16W
R46			RK73GB1J102J	CHIP R 1.0K	J 1/16W
R47			RK73GB1J103J	CHIP R 10K	J 1/16W
R49			RK73GB1J472J	CHIP R 4.7K	J 1/16W
R52			RK73GB1J104J	CHIP R 100K	J 1/16W
R54			RK73GB1J104J	CHIP R 100K	J 1/16W
R71			RK73GB1J103J	CHIP R 10K	J 1/16W
R72			RK73GB1J102J	CHIP R 1.0K	J 1/16W

E: Europe K: North America M: Other Areas
W: Without Europe

K : Z727
M : KDC-Z727

△ indicates safety critical components.

KDC-Z727,Z727

PARTS LIST

* New Parts

Parts without **Parts No.** are not supplied.

Les articles non mentionnes dans le **Parts No.** ne sont pas fournis.

Teile ohne **Parts No.** werden nicht geliefert.

CD PLAYER UNIT (X32-5030-01)

Ref. No.	A d d	N e w	Parts No.	Description	Dest inati on
R73			RK73GB1J473J	CHIP R 47K J 1/16W	
R75			RK73GB1J333J	CHIP R 33K J 1/16W	
R76			RK73GB1J622J	CHIP R 6.2K J 1/16W	
R77			RK73GB1J563J	CHIP R 56K J 1/16W	
R78			RK73GB1J243J	CHIP R 24K J 1/16W	
R81			RK73GB1J333J	CHIP R 33K J 1/16W	
R82			RK73GB1J123J	CHIP R 12K J 1/16W	
R83			RK73GB1J102J	CHIP R 1.0K J 1/16W	
R101,102			RK73GB1J332J	CHIP R 3.3K J 1/16W	
R103,104			RK73GB1J562J	CHIP R 5.6K J 1/16W	
R107,108			RK73FB2A331J	CHIP R 330 J 1/10W	
R117,118			RK73FB2A203J	CHIP R 20K J 1/10W	
R121,122			RK73FB2A203J	CHIP R 20K J 1/10W	
R125,126			RK73FB2A203J	CHIP R 20K J 1/10W	
R202			RK73GB1J104J	CHIP R 100K J 1/16W	
R213			RK73GB1J104J	CHIP R 100K J 1/16W	
R218			RK73GB1J473J	CHIP R 47K J 1/16W	
R233			RK73GB1J622J	CHIP R 6.2K J 1/16W	
R234			RK73GB1J103J	CHIP R 10K J 1/16W	
W17			R92-2053-05	CHIP R 0 J 1/8W	
S1 ,2			S68-0838-05	PUSH SWITCH	
S3			S68-0859-05	PUSH SWITCH	
D1 ,2			DAN202U	DIODE	
D3			DA204U	DIODE	
D4			DAN202U	DIODE	
IC1			AN22000AA	ANALOGUE IC	
IC2			MN662773KF1	MOS-IC	
IC4			BA5917AFP	ANALOGUE IC	
IC5			TA78L05F	IC(VOLTAGE REGULATOR/ +5V)	
IC6			NJM4565MD	IC(OP AMP X2)	
Q1			MCH6101	TRANSISTOR	
Q2			DTC124EUA	DIGITAL TRANSISTOR	
Q3 ,4			2SA1362(Y)	TRANSISTOR	
Q5			DTC124EUA	DIGITAL TRANSISTOR	
CD MECHANISM ASSY (X92-4190-01)					
401	2A		A10-4482-01	CHASSIS	
402	1B		A10-4225-33	CHASSIS CALKING ASSY	
403	2B		A11-0915-43	SUB CHASSIS CALKING ASSY	
405	2A		D10-3082-13	ARM	
405A	2A		D10-4038-23	ARM ASSY	
406	2A		D10-4306-14	ARM ASSY	
407	2A		D10-4305-14	ARM ASSY	
408	3A		D10-3087-44	ARM ASSY	
409	3B		D10-3092-03	SLIDER	
410	3B		D10-3093-04	SLIDER ASSY	
411	2B		D10-3095-04	SLIDER ASSY	
412	2B		D10-3096-04	SLIDER ASSY	
413	1A		D10-3099-24	SLIDER ASSY	
414	1A		D10-3100-04	SLIDER ASSY	
415	2A		D10-4123-24	LEVER ASSY	
416	1B		D10-4004-04	LEVER ASSY	
417	1B		D10-4006-04	LEVER	
418	1A		D10-4007-04	LEVER	

Ref. No.	A d d	N e w	Parts No.	Description	Dest inati on
419	2B		D10-4008-14	LEVER	
420	2A		D10-4009-23	ARM	
421	3A		D10-4010-04	LEVER	
422	3A		D10-4307-04	LEVER ASSY	
424	3B		D10-4050-04	ARM	
427	3A		D13-1442-03	RACK (GEAR)	
429	3B		D13-1231-04	GEAR	
430	3A		D13-1240-04	GEAR	
431	3B		D13-1233-04	GEAR	
432	3B		D13-1234-14	GEAR ASSY	
433	3A		D13-1441-03	GEAR	
434	3B		D13-1232-04	GEAR	
435	3B		D13-1241-04	GEAR	
436	3A		D13-1242-04	GEAR	
437	1B		D13-1243-04	GEAR	
438	1B		D13-1244-04	GEAR	
439	1B		D13-1245-14	GEAR	
440	2A		D13-1246-04	GEAR	
441	2B		D13-1247-04	GEAR	
443	2B		D13-1249-04	GEAR ASSY	
444	2B		D13-2090-04	GEAR ASSY (LEAD SCREW)	
445	1B		D14-0668-04	ROLLER	
446	1A		D14-0670-04	ROLLER	
447	3B		D14-0674-04	ROLLER	
449	3A		D21-2228-14	SHAFT	
450	1A		D21-2229-04	SHAFT	
451	1A		D23-0925-24	RETAINER	
452	2A		D32-0614-04	STOPPER	
453	1B		D39-0223-05	DAMPER	
454	2B		D39-0224-05	DAMPER	
455	3B		F09-1246-04	SHEET	
458	3B		F09-1266-14	SHEET	
460	2A		G01-2770-04	EXTENSION SPRING	
461	3A		G01-2771-04	EXTENSION SPRING	
462	3A		G01-2772-24	EXTENSION SPRING	
463	3A		G01-2773-14	EXTENSION SPRING	
464	3A		G01-2774-34	EXTENSION SPRING	
465	1B		G01-2775-04	TORSION COIL SPRING	
466	1B		G01-2776-14	TORSION COIL SPRING	
467	3B		G01-2777-24	TORSION COIL SPRING	
469	2A		G01-2844-04	EXTENSION SPRING	
470	2A		G02-1231-04	FLAT SPRING	
471	2B		G02-1232-24	FLAT SPRING	
472	2A		G02-1241-24	FLAT SPRING	
475	2A		J11-0613-13	CLAMPER	
476	3A		J19-4678-13	HOLDER	
477	2B		J19-4679-24	HOLDER	
478	3B		J21-7684-13	MOUNTING HARDWARE	
479	2B		J21-7686-13	MOUNTING HARDWARE	
480	1B		J21-7690-03	MOUNTING HARDWARE	
482	3A		J84-0107-05	FLEXIBLE PRINTED WIRING BOARD	
483	1A		J90-0757-22	GUIDE	
A	2A		N09-4249-05	MACHINE SCREW (M1.7X2.5,LOCK)	

KDC-Z727,Z727

PARTS LIST

* New Parts

Parts without **Parts No.** are not supplied.

Les articles non mentionnes dans le **Parts No.** ne sont pas fournis.

Teile ohne **Parts No.** werden nicht geliefert.

CD MECHANISM ASSY (X92-4190-01)

Ref. No.	A d d	N e w	Parts No.	Description	Dest inati on
B	1B		N09-4172-05	TAPPING SCREW (2X3.5,C TITE)	
C	2B		N09-4202-05	STEPPED SCREW	
D	2A		N38-2020-46	PAN HEAD MACHIN SCREW	
E	3A		N09-4294-05	TAPTITE SCREW (BIND P TAPTIT)	
F	3B		N19-2023-04	FLAT WASHER	
G	2A		N19-2058-04	FLAT WASHER	
H	3A		N19-2093-04	FLAT WASHER	
J	2A		N39-2020-46	PAN HEAD MACHIN SCREW	
DM1	3A		T42-0764-04	DC MOTOR ASSY(SP)	
DM2	3B		T42-1028-04	DC MOTOR ASSY(SL)	
DPU1	2B		T25-0215-05	OPTICAL PICKUP HEAD	

Ref. No.	A d d	N e w	Parts No.	Description	Dest inati on

E: Europe K: North America M: Other Areas
W: Without Europe

K : Z727
M : KDC-Z727

△ indicates safety critical components.

KDC-Z727,Z727

SPECIFICATIONS

		KDC-Z727	Z-727
FM	Frequency Range (50kHz space)	87.5MHz~108.0MHz	-
	(200kHz space)	87.9MHz~107.9MHz	87.9MHz~107.9MHz
	Usable Sensitivity (S/N=30dB)	9.3dBf (0.8μV/75Ω)	9.3dBf (0.8μV/75Ω)
	Quieting Sensitivity (S/N=50dB)	15.2dBf (1.6μV/75Ω)	15.2dBf (1.6μV/75Ω)
	Frequency Response (±3.0dB)	30Hz-15kHz	30Hz-15kHz
	Signal to Noise ratio (MONO)	70dB	70dB
	Selectivity (±400kHz)	≥80dB	≥80dB
	Stereo Separation (1kHz)	40dB	40dB
AM	Frequency Range (9kHz space)	531kHz~1611kHz	-
	(10kHz space)	530kHz~1700kHz	530kHz~1700kHz
	Usable Sensitivity (S/N=20dB)	28dBμ (25μV)	28dBμ (25μV)
CD	Laser Diode	GaAlAs (λ=780nm)	GaAlAs (λ=780nm)
	Digital Filter (D/A)	8 Times Over Sampling	8 Times Over Sampling
	D/A Converter	1Bit	1Bit
	Spindle Speed (CD-DA)	500~200rpm (CLV)	500~200rpm (CLV)
	Wow & Flutter	Below Measurable Limit	Below Measurable Limit
	Frequency Response (±1dB)	10Hz-20kHz	10Hz-20kHz
	Total Harmonic Distortion (1kHz)	0.01%	0.01%
	Signal to Noise Ratio (1kHz)	93dB	93dB
	Dynamic Range	93dB	93dB
	Channel Separation	85dB	85dB
AUDIO	Maximum Output Power	47Wx4	47Wx4
	Full Bandwidth Power (at less than 1% THD)	22Wx4	22Wx4
	Tone Action Bass:	100Hz±10dB	100Hz±10dB
	Middle:	1kHz±10dB	1kHz±10dB
	Treble:	10kHz±10dB	10kHz±10dB
Preout Level/Load (during disc play)		4500mV/10kΩ	1800mV/10kΩ
Preout Impedance		80Ω	≤600Ω
GENERAL	Operating Voltage (11V-16V allowable)	14.4V	14.4V
	Current Consumption	10A	10A
	Installation Size (WxHxD)	182x53x156mm	182x53x156mm 7-3/16x2-1/16x6-1/8inch
	Weight	1.8kg	4.06lbs(1.8kg)

KENWOOD follows a policy of continuous advancements in development. For this reason specifications may be changed without notice.

KENWOOD CORPORATION

14-6, Dogenzaka 1-chome, Shibuya-ku, Tokyo 150-8501 Japan

KENWOOD SERVICE CORPORATION

P.O. BOX 22745, 2201 East Dominguez Street, Long Beach, CA90801-5745, U.S.A.

KENWOOD ELECTRONICS CANADA INC.

6070 Kestrel Road, Mississauga, Ontario, Canada L5T 1S8

KENWOOD ELECTRONICS LATIN AMERICA S.A.

P.O. Box 55-2791 Paillilla, Plaza Credicorp Bank Panama, Piso 9, Oficina 901, Calle 50, Panama, Rep. de Panama

KENWOOD ELECTRONICS BRASIL LTDA.

Av. Moema, 170-17, Andar-Cobertura "B", Ed. Maximum Service Center, 04077-020 Moema, São Paulo-SP-Brasil

KENWOOD ELECTRONICS UK LIMITED

Kenwood House, Dwight Road, Watford, Herts, WD1 8EB, United Kingdom

KENWOOD ELECTRONICS DEUTSCHLAND GMBH

Rembrücker-Str. 15, 63150 Heusenstamm, Germany

KENWOOD ELECTRONICS FRANCE S.A.

13, Boulevard Ney, 75018 Paris, France

KENWOOD ELECTRONICS BELGIUM N.V.

Mechelsteeweg 418, B-1930 Zaventem, Belgium

KENWOOD ELECTRONICS ITALIA S.p.A.

Via G. Sirtori 7/9, 20129 Milano, Italy

KENWOOD IBÉRICA S.A.

Bolivia, 239-08020 Barcelona, Spain

KENWOOD ELECTRONICS AUSTRALIA PTY. LTD. (A.C.N. 001 499 074)

16 Giffnock Avenue, Centrecourt Estate, North Ryde, N.S.W. 2113, Australia

KENWOOD ELECTRONICS (HONG KONG) LTD.

Unit 3712-3724, Level 37, Tower 1, Metroplaza, 223 Hing Fong Road, Kwai Fong, N.T., Hong Kong

KENWOOD ELECTRONICS GULF FZE

P.O. Box 61318, Jebel Ali, Dubai, U.A.E.

KENWOOD ELECTRONICS (THAILAND) CO., LTD.

2019 New Pechburi Road, Bangkok, Huaykwang, Bangkok, 10320 Thailand

KENWOOD ELECTRONICS SINGAPORE PTE. LTD.

1 Genting Lane, #07-00, Kenwood Building, Singapore, 349544

KENWOOD ELECTRONICS (MALAYSIA) SDN BHD

#4.01 Level 4, Wisma Academy Lot 4A, Jalan 19/1, 46300 Petaling Jaya, Selangor Darul Ehsan, Malaysia